

Single-line automatic lubrication systems

Product catalogue 2021

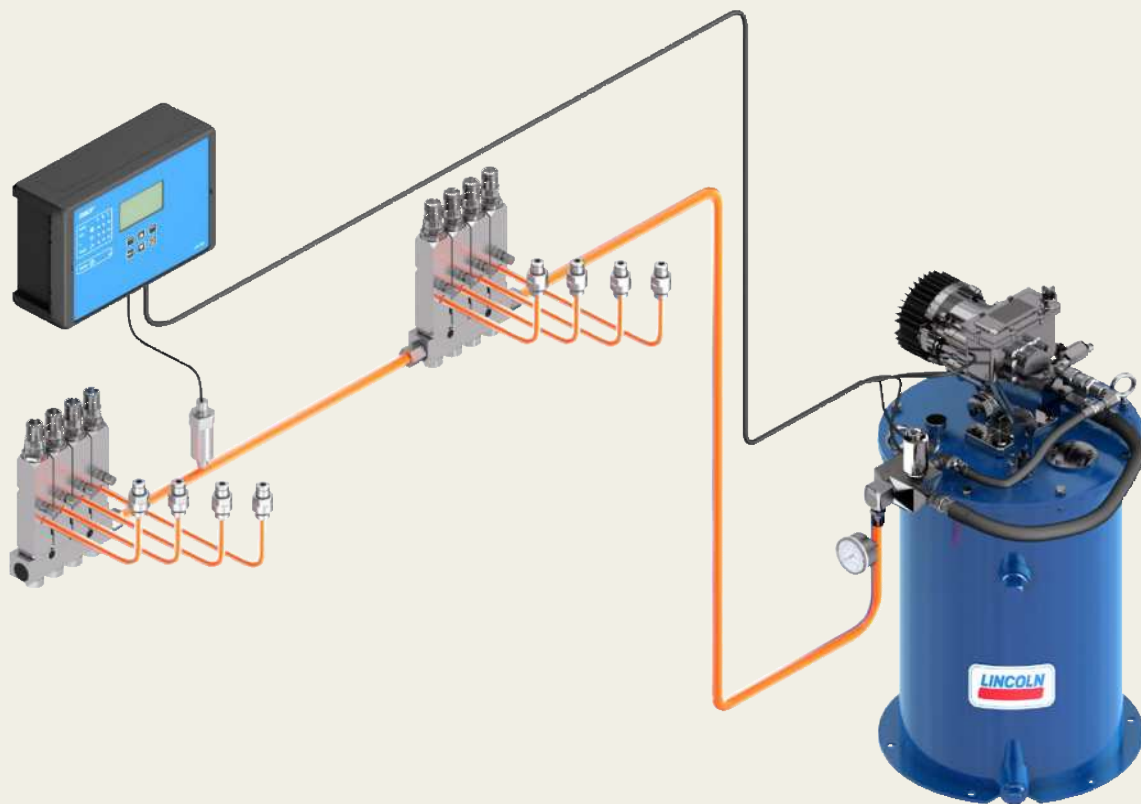

Electronic part library

CAD product data

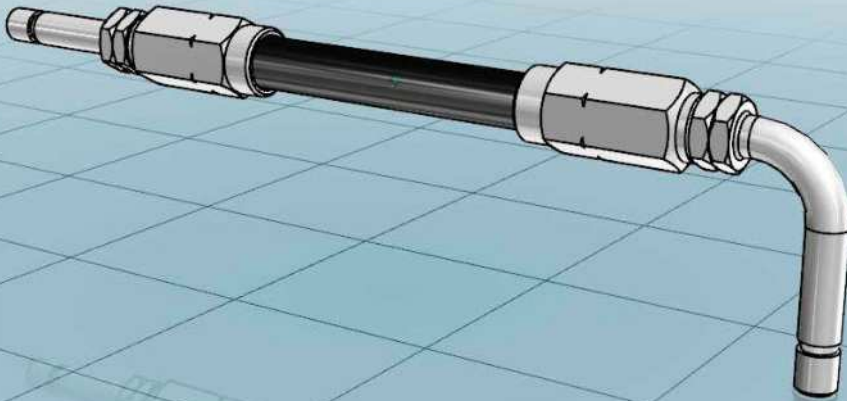

Find your parts online

3D CAD data, technical drawings and data sheets of SKF automatic lubrication system components are now available in native format in the online parts library. In addition to enjoying easy CAD downloads, you can configure more complex lubrication system products and integrate them into your design process – completely free of charge. Integrate CAD data seamlessly into your layout plans without any delay.



<https://skf-lubrication.partcommunity.com>

Use the parts library app

In addition to the electronic parts library, SKF offers a mobile app that allows you to use the SKF CAD download portal for lubrication systems. The LubCAD app lets you view, configure and download products and parts in the most common CAD file formats. You can also download related product brochures or find an authorized distributor in your area.



Apple App Store



Google Play

Introduction 2

Pumps and pump units for oil 13

Pumps and pump units for grease 49

Metering devices for oil 93

Metering devices for grease 131

Control units. 151

Pressure sensors 169

Flow monitors and sensors 187

Solenoid valves 191

Table of contents

Electronic part library	2	83599	62
Two leading brands	6	HG 1000, HG 2000	63
Lubricants suitable for lubrication systems	7	BPH	64
Single-line lubrication systems for oil and fluid grease	8	84944, 84961	66
Single-line lubrication systems for grease	10	84960, 84962	67
Overview of oil and fluid grease pumps and pump units	13	FlowMaster, hydraulic	68
MCP	14	MPB	70
1812	16	84050, 85460	72
P-846-2	17	282288	73
283167	18	FlowMaster, air operated	74
82885, 83667	19	P 603S	76
85438/40/41	20	Minilube	78
P/PW/PF/PFW-289	21	KFG	80
ACP	22	Multilube MLPV/MLPI	82
PPS30	24	P 653S	84
P-886	26	E-PUMP	86
82676	27	FK	88
82570	28	FlowMaster, electric	90
85430/31/32/33	29	Overview of oil and fluid grease metering devices	93
PEF/PEU	30	341	94
1826	31	340	96
ECP	32	LS22	98
P 653S (oil)	34	LS21	99
KFB	36	361	100
KFB-M	38	310	102
KFU	40	351	104
MKU	42	350	106
MKF	44	370	108
MFE	46	391	110
Overview of grease pumps and pump units	49	Manifold	111
83817	52	390	112
1810	53	321 G, T, W, G4, Module, G7	114
40PGA	54	AB	116
82886, 83668	56	VN	118
85442	57	OI-AL-SR	120
85444/45	58	SL-42	122
85434/35/36	59	SL-43	124
82653/55, 83800/34	60	SL-41	126
83167	61	SL-44	128

Table of contents

Overview of grease metering devices	131	Overview of pressure sensors	169
SL-33	132	DSA	170
B-doser	134	DSD	172
LG-doser	136	DSB1	174
SL-32HV	138	69630	176
SL-1	139	DSC1	177
QSL	140	DSC2	178
VR	142	DSC3	179
SLC	144	234-13161-9	180
SL-11	146	2340-00000118	181
SL-V	147	234-10330-4	182
SL-V XL	148	234-11272-4	183
		234-13161-5	184
Overview of control units	151	2340-00000108	185
EXZT/IGZ	152	Overview of flow monitors and sensors	187
IG502-2-E	154	GS304P	188
LC502	155	HCC	189
ST-2240-LUB	156	Overview of solenoid valves	191
ST-1240	157	35024	192
ST-1100i	158	350282, 350283	193
ST-102	159	253-14076-X	194
ST-102P	160	525-320 ...-1	195
84501	161	161-110-031	196
LMC 101	162	161-140-050	197
EOT-1/2 664-34135-6, 664-34135-7	163	Index	198
85307	164	Notes	202
LMC 2	165		
LMC 301	166		

Two leading brands



One global leader

SKF and Lincoln have joined forces to provide you with the world's most complete portfolio of innovative lubrication solutions – from manual lubricators and tools, to the most advanced centralized and automatic lubrication systems available.

In addition to traditional lubrication products and systems, we offer customized solutions for many industries such as pulp and paper, steel, mining, agriculture, marine, rail, wind, construction, machine tool and automotive. SKF engineering and technical specialists partner with OEMs and end-users to develop system solutions based on customer requirements. We also offer a variety of control and monitoring equipment for ease of use and to help ensure proper lubrication.

Both SKF and Lincoln systems are available through our global network of lubrication experts, offering you world-class installation and ongoing support on a local level – today and into the future. With the power of this network, and more than 200 years of combined friction management experience, we can help you improve machine reliability, reduce maintenance, increase productivity, enhance safety and optimise manpower resources.

Lubricants suitable for lubrication systems

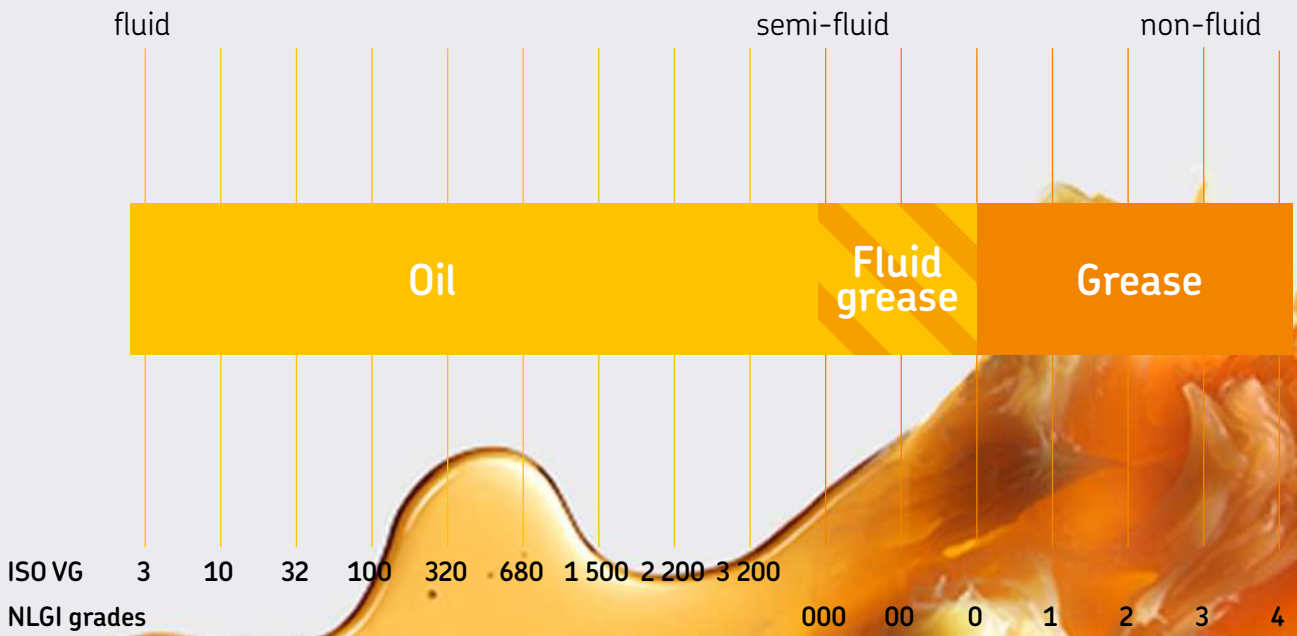

Oil and fluid grease

The viscosity is an expression of a fluid's internal friction. Oils are classified in ISO VG viscosity classes from 2 to 3 200. NLGI grade 000, 00 and 0 greases are called fluid greases. Different types of oils are available, including mineral oils, organic oils and synthetic oils. A compatibility check is recommended prior to using any oil with SKF lubrication systems.



Grease

Greases are consistent lubricants (NLGI grade 1–6). They are soft to hard, triple-component mixtures of a base oil as the lubricating fluid, a thickening agent and additives. In most instances, greases of NLGI grade 1 up to 3 are suitable for use in a lubrication system. A compatibility check should be made prior to using any grease with SKF lubrication systems.



System video

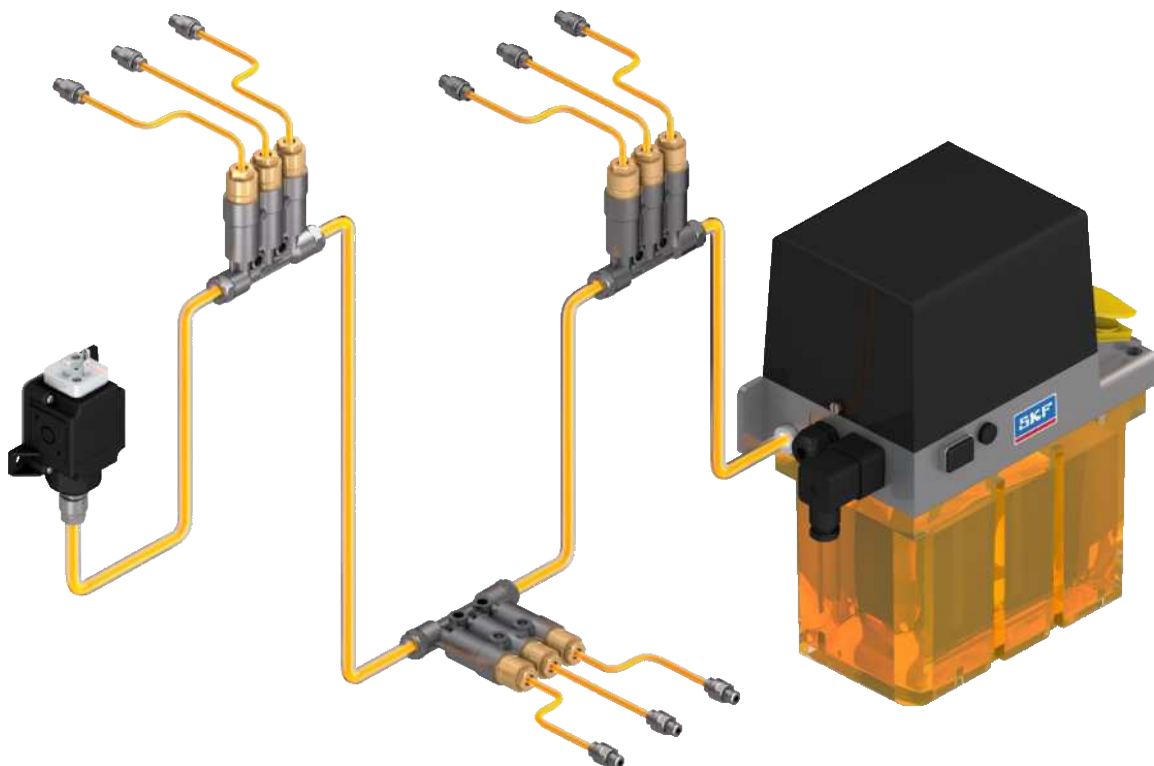

System description

Regardless of the application, the principle of single-line lubrication remains the same: a central pump station automatically delivers lubricant through a single supply line to the lubricant metering device. Each metering device serves only one lubrication point and may be adjusted to deliver the precise amount of grease or oil required. Systems can service one machine, different zones on one machine or even several separate machines. The SKF portfolio includes both SKF MonoFlex and Lincoln Centro-Matic system components including pumps, metering units, control and monitoring devices and accessories.

For planning a lubrication system, conditions the system will be used in need to be determined first. The number of lubrication points, back pressures at the lubrication points, operating temperature range, lubricant, the feed pump's drive energy, control and monitoring etc. need to be defined correctly. Attention to information on bearing or lubrication point information need to be paid too. The sum of all the quantities metered out by the system's metering devices needs to be completed by safety margin and expansion and compressibility loss.

SKF application engineers, as well as SKF sales partners and distributors, are experts in laying out lubrication systems according to all these specifications. A lubrication system laid out by SKF and partners ensures the supply of the correct amount of lubricant at the best time to lubricate. This reduces wear and avoids pollution caused by over-lubrication.

Advantages:

- Easy to understand, install and maintain
- Available in both preset and adjustable models
- Suitable for almost all lubricants
- Easy system expansion
- System continues to operate if one point becomes blocked
- Integrated system control and monitoring
- Able to pump long distances and within a wide temperature range



Applications

In total loss lubrication systems, fresh lubricant is fed to friction points during a lubrication cycle. The lubrication cycle is set up so that friction points are supplied with enough lubricant to build up an adequate film of lubricant, reducing wear and tear on bearings and friction points. Monoflex and Centromatic systems are designed to allow for easy expansion and simple assembly.

Applications for single-line systems include small-to-medium machine tools, mobile on-road (fleet vehicles, on-road transport), and assembly/automation food packaging, part assembly lines and injection molding:

- Small-to-medium line length
- Small-to-medium quantities of lubricant per lubrication point
- Ease of expansion
- Linear layout of lubrication points
- Flexibility of lubricant distribution
- Easy monitoring of lubrication distribution



System video

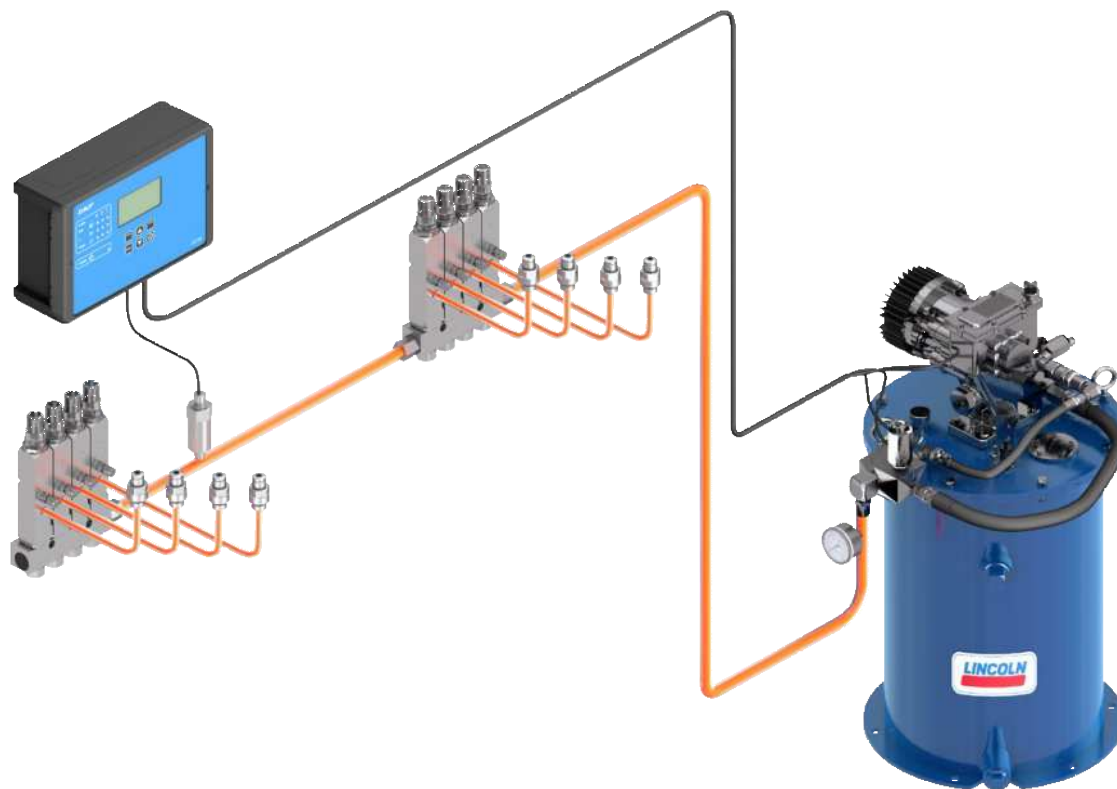

System description

Regardless of the application, the principle of single-line lubrication remains the same: a central pump station automatically delivers lubricant through a single supply line to the lubricant metering device. Each metering device serves only one lubrication point and may be adjusted to deliver the precise amount of grease or oil required. Systems can service one machine, different zones on one machine or even several separate machines. All single-line systems include a pump, injectors, controller and a pressure switch /transducer. These components are very easy to install and modify on any application as needed.

SKF offers two brands of single line parallel lubrication systems: the Lincoln Centro-Matic and the SKF MonoFlex. These systems are recognized world wide for their reliability to lubricate in adverse conditions in virtually any application. For planning a lubrication system, conditions the system will be used in need to be determined first. The number of lubrication points, back pressures at the lubrication points, operating temperature range, lubricant, the feed pump's drive energy, control and monitoring etc. need to be defined correctly.

Attention to information on bearing or lubrication point specifications need to be paid too. The sum of all the quantities metered out by the system's metering devices needs to be completed by safety margin and compressibility loss.

SKF application engineers, as well as SKF sales partners and distributors, are experts in laying out lubrication systems according to all these specifications. A lubrication system laid out by SKF and partners ensures the supply of the correct amount of lubricant at the best time to lubricate. This reduces wear and it avoids pollution caused by over-lubrication.

Advantages:

- Easy to understand, install and maintain
- Fully adjustable or customizable for any application
- Suitable for almost all lubricants
- Simple system expansion
- System continues to operate if one point becomes blocked
- Integrated system control and monitoring
- Able to pump long distances within a wide temperature range



Applications

Mining applications have been installed in the far north including the Oil Sands of Canada and Siberia and in the hot deserts of Africa and Australia. Major food, beverage, oil/gas, cement, steel, construction and rail customers also rely on SKF's single-line products. Single-line applications benefit from SKF's method of delivering precise amounts of lubricant at controlled intervals to the lubrication point.

- Mining
- On/Off-road
- Construction machinery
- Cement industry
- Food and beverage
- Machine tools
- Railroad
- Forestry
- Steel
- And more



Overview of oil and fluid grease pumps and pump units

Manually operated pump units

Product	Lubricant		Metering quantity max.		Operating pressure max.		Reservoir		Metering device category ¹⁾				Page
	oil	fluid grease	cm ³ /stroke	in ³ /stroke	bar	psi	l	gal	1	2	3	4	
MCP	•	–	15	0.91	38	551	0,5; 1; 1,7	0.13; 0.26; 0.45	•	•	•	–	14
1812	•	•	2,6	0.16	69	1 000	2,1	0.55	–	•	•	•	16

¹⁾ Select the recommended fittings, adjust the pump pressure within the recommended metering device pressure range

Air-operated pumps and pump units

Product	Lubricant		Metering quantity max.		Operating pressure max.		Reservoir		Metering device category ¹⁾				Page
	oil	fluid grease	cm ³ /stroke	in ³ /stroke	bar	psi	l	gal	1	2	3	4	
P-846-2	•	–	7	0.42	45	652	–	–	•	•	•	–	17
283167	•	•	1,97	0.12	69	1 000	7,1	1.88	–	–	•	•	18
82885, 83667	•	•	7,4	0.45	69	1 000	0,6; 2	0.16; 0.53	–	•	•	•	19
85438 / 40 / 41	²⁾ •	•	7,4	0.45	69	1 000	0,6; 2	0.16; 0.53	–	•	•	•	20
P/PW/PF/PFW-289	•	•	10	0.61	40	580	1,5	0.39	•	•	•	–	21
ACP	•	–	15	0.91	38	551	0,5; 1; 1,7	0.13; 0.26; 0.45	•	•	•	–	22
PPS30	•	•	30	1.83	27	392	1,5	0.39	•	•	–	–	24
P-886	•	–	30	1.83	35	508	–	–	•	•	•	–	26
82676	•	•	39,3	2.39	69	1 000	–	–	–	–	–	•	27
82570	•	•	39,3	2.39	69	1 000	2	0.53	–	–	–	•	28
85430 / 31 / 32 / 33	²⁾ •	•	39,3	2.39	69	1 000	0,0; 2	0.0; 0.53	–	–	–	•	29
PEF/PEU	•	•	48	2.93	50	725	3	0.79	•	•	•	–	30

¹⁾ Select the recommended fittings, adjust the pump pressure within the recommended metering device pressure range

²⁾ Controller optionally

Air-operated barrel pumps

Product	Lubricant		Metering quantity max.		Operating pressure max.		Reservoir		Metering device category ¹⁾				Page
	oil	fluid grease	cm ³ /min	in ³ /min	bar	psi	l	gal	1	2	3	4	
1826	²⁾ •	•	7 571	462	69	1 000	200	52.83	–	•	•	•	31

¹⁾ Select the recommended fittings, adjust the pump pressure within the recommended metering device pressure range

²⁾ Controller optionally

Electrically operated pumps and pump units

Product	Lubricant		Metering quantity max.		Operating pressure max.		Reservoir		Metering device category ¹⁾				Page
	oil	fluid grease	cm ³ /min	in ³ /min	bar	psi	l	gal	1	2	3	4	
ECP	•	•	12	0.73	38	550	0,38	0.086	•	•	•	–	32
P653S (oil)	²⁾ ³⁾ •	•	24,6	1.5	240	3500	4; 8	1.05; 2.11	–	•	•	•	34
KFB	²⁾ •	•	50	3	38	550	1	0.26	•	•	•	–	36
KFB-M	²⁾ •	•	50	3	38	550	1	0.26	•	•	•	–	38
KFU	•	•	140	8.5	38	550	2,7; 6	0.71; 1.56	•	•	•	–	40
MKU	²⁾ •	–	100; 200; 500	6; 12; 31	30	435	2; 3; 6	0.53; 0.79; 1.56	•	–	–	–	42
MKF	²⁾ •	•	100; 200; 500	6; 12; 31	30	435	2; 3; 6	0.53; 0.79; 1.56	•	•	–	–	44
MFE	•	•	250; 500	15; 31	28	405	3; 6; 15	0.79; 1.56; 3.96	•	•	–	–	46

¹⁾ Select the recommended fittings, adjust the pump pressure within the recommended metering device pressure range

²⁾ Controller optionally

³⁾ With pressure transducer

Pump unit

MCP



PRODUCT
AVAILABLE
IN 2021



Description

The model MCP is a manual operated compact pump unit. Featuring a compact, lightweight design, that cost-effective pump is compatible with oil and fluid grease. Constructed of robust material, the pump is reliable in demanding applications. An optional fill-level monitor with prewarning functionality helps users to take early action.

Low operating pressures of up to 38 bar (551 psi) enable the use of SKF Quick Connector fittings and SKF single-line metering devices of category 1 without additional pressure regulation. The MCP pump replaces pump series POE/PFE.

Feature and benefits

- Simple to use
- Easy system integration
- Reliable operation
- Lightweight and robust design, compact size
- Fill-level monitoring
- Simple maintenance
- Suitable for use with metering devices of category 1

Applications

- Simple machine tool and punching/laser machinery
- Process and packaging machinery
- Material handling devices
- Textile machinery
- Chain lubrication
- Cartesian robots
- Etc.

Technical data

Function principle	manually operated piston pump
Outlets	2
Metering quantity	up to 15 cm ³ /stroke up to 0.91 in ³ /stroke
Lubricant	mineral and synthetic oils with an operating viscosity of 20–1 500 mm ² /s fluid greases: NLGI 000, 00
Operating temperature	0 to +60 °C; 32 to 140 °F
Operating pressure	max. 38 bar; 551 psi
Reservoir	0,5; 1,0; 1,7 l 0.13; 0.26; 0.45 gal
Protection class	IP 54
Material (reservoir)	acrylic
Connection outlet	G ¹ / ₄ × 12 mm
Dimensions	
0,5 l	124 × 190 × 289 mm; 4.89 × 7.48 × 11.38 in
1,0 l	124 × 190 × 379 mm; 4.89 × 7.48 × 14.92 in
1,7 l	124 × 190 × 489 mm; 4.89 × 7.48 × 19.25 in
Mounting position	vertical
Weight (dep. on model)	1,3–2,6 kg; 2.8–5.7 lb



NOTE

Further technical information, technical drawings, accessories, spare parts or product function descriptions available on SKF.com/lubrication.

Pump unit

MCP

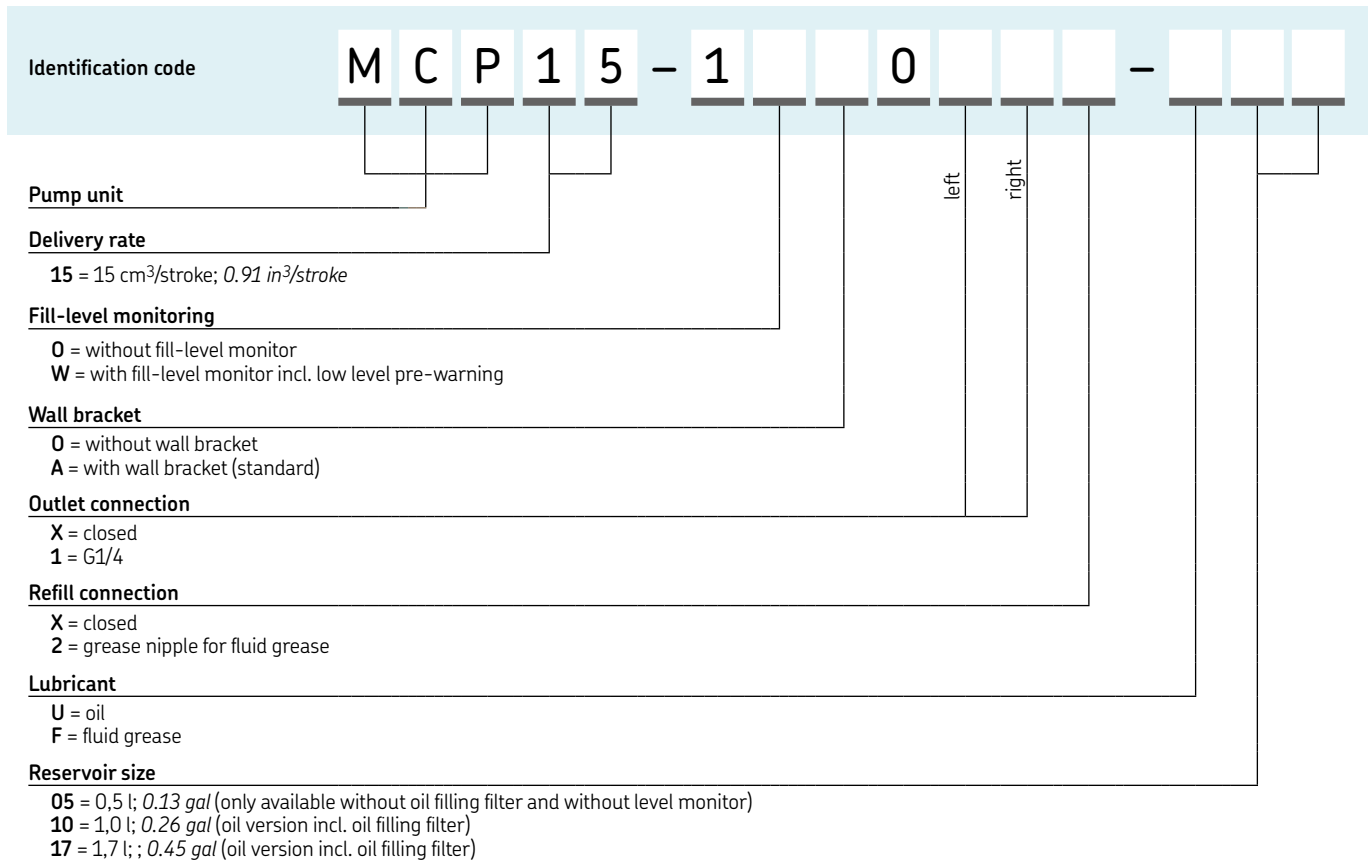

MCP standard product range

Order number	Description
MCP15-10A01X2-F05	MCP for fluid grease with 0,5 l reservoir, without fill level monitor
MCP15-10A01X2-F10	MCP for fluid grease with 1,0 l reservoir, without fill level monitor
MCP15-1WA01X2-F10	MCP for fluid grease with 1,0 l reservoir, with fill level monitor
MCP15-10A01X2-F17	MCP for fluid grease with 1,7 l reservoir, without fill level monitor
MCP15-1WA01X2-F17	MCP for fluid grease with 1,7 l reservoir, with fill level monitor
MCP15-10A01XX-U05	MCP for oil with 0,5 l reservoir, without fill level monitor
MCP15-10A01XX-U10	MCP for oil with 1,0 l reservoir, without fill level monitor
MCP15-1WA01XX-U10	MCP for oil with 1,0 l reservoir, with fill level monitor
MCP15-10A01XX-U17	MCP for oil with 1,7 l reservoir, without fill level monitor
MCP15-1WA01XX-U17	MCP for oil with 1,7 l reservoir, with fill level monitor

- Order example**
- MCP15-10A01XX-U17
- manual-operated compact pump
 - delivery rate 15 cm³/stroke
 - without fill-level monitoring
 - with wall bracket
 - without inlet connection
 - G1/4 outlet connection left
 - closed outlet connection right
 - refill connection closed
 - oil version
 - reservoir 1,7 liter (with oil filling filter)

Pump unit

1812



Description

The 1812 pump features a translucent reservoir with filler cap and strainer. Its pump base has an integrated check/vent valve and an indicator pin to show when system pressure is achieved.

Feature and benefits

- Provides precise lubrication where air or electricity are not available
- Built-in vent valve activates when handle is pushed all the way up
- Pressure stem indicates 58 bar; 850 psi
- Suitable for use with metering devices of category 2, 3, 4

Applications

- Textile
- Stationary
- Material handling including presses
- Agriculture and farming



Technical data

Order number	1812
Function principle	manually operated piston pump
Outlets	1
Metering quantity	2,6 cm ³ /stroke, 0.16 in ³ /stroke
Lubricant	oil, synthetic oil on request
Operating temperature	-23 to +65 °C -10 to +150 °F
Operating pressure	max. 70 bar, 1 000 psi
Reservoir	2,13 l; 2 130 cm ³ 0.5 gal, 130 in ³
Material (reservoir)	acrylic
Connection outlet	1/4 NPTF (F)
Dimensions	425 × 181 × 197 mm 16.75 × 7.125 × 7.75 in
Mounting position	vertical



NOTE

Further technical information, technical drawings, accessories, spare parts or product function descriptions available on SKF.com/lubrication.

Pump unit

P-846-2



Description

Pump P-846-2 is an oil pump without reservoir made from metal, designed for remote or bulk-fill oil applications. It discharges lubricant on the air-powered forward stroke and releases pressure on the lubricant line through included check/relief valve through a M10x1 oil outlet.

Features and benefits

- Designed for remote or bulk-fill oil applications
- Remote system components available upon request
- Suitable for use with metering devices of category 1–3

Applications

- Plastic processing
- Food and beverage
- Material handling
- Packaging



Technical data

Order number	P-846-2
Function principle	air operated piston pump
Outlets	1
Metering quantity	7 cm ³ /stroke, 0.42 in ³ /stroke
Lubricant	mineral or synthetic oils, compliant with plastic, NBR-elastomers, cooper and copper alloys
Operating temperature	10 to +60 °C 50 to +140 °F
Operating pressure	max. 45 bar, max. 652 psi
Actuation pressure	2,5–8 bar, 36–116 psi
Reservoir	external
Connection outlet	M10x1
Connection inlet	M14x1,5
Air inlet connection	M10x1
Protection class	IP 54
Dimensions	85 x 134 x 85 mm 3.34 x 5.27 x 3.34 in
Mounting position	any



NOTE

Further technical information, technical drawings, accessories, spare parts or product function descriptions available on SKF.com/lubrication.

Pump unit

283167



Description

Pump model 283167 includes air motor, vent valve, translucent reservoir with filler cap, strainer and 1 200 psi (82 bar) safety unloader. Pump is an oscillating positive displacement pump with pneumatic drive. The change-over valve of the pump drive controls reciprocating of the pump strokes (discharges oil to outlet on forward stroke and sucks oil on back stroke). The reciprocating pump operates under air pressure and as such discharges material until the required system oil pressure is built up. The shut off and monitoring of the pump must be initiated by a pressure switch, 3/2 way air valve, components to limit and adjust the air operating pressure. These parts are to be furnished on site of the user.

Features and benefits

- Reservoir with filler cap and internal strainer
- Vent valve assembly enclosed
- Remote system components available upon request
- Suitable for use with metering devices of category 3 and 4

Applications

- Steel mills
- Glass manufacturing plants
- Packaging
- Plastic processing
- Material handling
- Food and beverage
- Metal cutting, metal forming
- Systems with many lubrication points



Technical data

Order number	283167
Function principle	air, reciprocating piston pump
Outlets	1
Metering quantity	1,97 cm ³ /stroke, 0.12 in ³ /min
Working frequency	max. 100 cycles/min
Lubricant	oil, synthetic oils on request
Operating temperature	-23 to +65 °C -10 to +150 °F
Operating pressure	max. 70 bar, 1 000 psi
Reservoir	7,1 l, 7 100 cm ³ , 1.8 gal, 433 in ³
Material (reservoir)	acrylic
Air inlet connection	1/8 NPTF (F)
Connection outlet	3/4 NPTF (F)
Transmission ratio	40:1
Air valve	required, 3-way
Dimensions	591 × 229 × 413 mm 23.25 × 9 × 16.25 in
Mounting position	vertical

Note:
When operating the pump with air pressure > 1,7 bar a pressure switch for oil is required to limit the oil pressure (max. 68 bar) of the central lubrication system.



NOTE

Further technical information, technical drawings, accessories, spare parts or product function descriptions available on SKF.com/lubrication.

Pump unit

82885, 83667



Description

Model 82885, an air-operated, single-stroke oil pump, discharges lubricant on an air-powered forward stroke and releases pressure on the lubricant line on a spring-powered return stroke through an integrated check/relief valve (3 way). Its translucent reservoir is refilled through a filler cap with strainer. The pump unit is suitable for systems with a large number of lubrication points and clocked greasing strokes. Model 83667 offers the same features but includes a larger reservoir.

Feature and benefits

- Reliable operation
- Reservoir with filler cap and internal strainer
- Suitable for use with metering devices of category 2, 3 and 4

Applications

- Textiles
- Steel mills
- Packaging
- Plastic processing
- Material handling
- Food and beverage

Technical data

Function principle	air operated piston pump
Outlets	1
Metering quantity	7,4 cm ³ /stroke, 0.45 in ³ /stroke
Working frequency	
Lubricant	oil, synthetic oils on request
Operating temperature	-23 to +65 °C -10 to +150 °F
Operating pressure	max. 70 bar, 1 000 psi
Reservoir	0,6 and 2,0 l; 0.16 and 0.5 gal
Material (reservoir)	acrylic
Connection outlet	1/4 NPTF (F)
Air inlet connection	1/4 NPTF (F)
Transmission ratio	20:1
Air valve	required, 3-way
Dimensions	min. 263 × 133 × 152 mm max. 470 × 140 × 152 mm min. 10.375 × 5.25 × 6 in max. 18.5 × 5.5 × 6 in
Mounting position	vertical

Order information

Order number	Reservoir	
	l	gal
82885	0,6	0.16
83667	2,0	0.5



NOTE

Further technical information, technical drawings, accessories, spare parts or product function descriptions available on SKF.com/lubrication:

442832



3D

skf-lubrication.partcommunity.com/3d-cad-models

Pump unit

85438/40/41



Description

Pump models 85438/40/41 are air-operated, positive displacement pumps that deliver a maximum volume by means of a single stroke of the pump. Solenoid air valve and adjustable solid-state time controls are integrated into the pump body. These pumps are designed to deliver fluid lubricants to single-line injectors and are filled via a spring-loaded filler cap and internal strainer. Acrylic reservoirs are available in two sizes. Supply voltages are offered in 120 VAC and 240 VAC.

Features and benefits

- Reservoir with filler cap and internal strainer
- Integrated, adjustable, solid-state time controls with LED indicators for "Power On," "Pump On" and "Alarm," along with a membrane-type "Manual Lube" switch
- Integrated solenoid air valve
- Suitable for use with metering devices of category 2, 3 and 4

Applications

- Textiles
- Steel mills
- Plastic processing
- Material handling
- Food and beverage

Technical data

Function principle	air operated piston pump (single stroke)
Outlets	1
Metering quantity	7,4 cm ³ /stroke; 0.45 in ³ /stroke
Working frequency	
Lubricant	oil, synthetic oils on request
Operating temperature	-23 to +65 °C -10 to +150 °F
Operating pressure	max. 70 bar, 1 000 psi
Reservoir	
85438	0,6 l; 0.16 gal
85440, 85441	2,0 l; 0.5 gal
Material (reservoir)	acrylic
Connection outlet	1/4 NPTF (F)
Voltage	120 VAC, 240 VAC
Transmission ratio	20:1
Dimensions:	
85438	133 × 184 × 305 mm 5.25 × 7.24 × 12.02 in
85440, 85441	133 × 184 × 527 mm 5.25 × 7.24 × 20.75 in
Mounting position	vertical
Timer and controller	
On time	10 or 30 sec
Off time	30 sec to 30 min. or 30 min. to 30 h
Alarm contacts	8 A at 250 VAC
Operating temperature	-23 to 65 °C; -10 to +150 °F

Order information

Order number	Voltage		Reservoir	
	VAC		l	gal
85438	120		0,6	0.16
85440	120		2,0	0.5
85441	240		2,0	0.5



NOTE

Further technical information, technical drawings, accessories, spare parts or product function descriptions available on SKF.com/lubrication:

442832



3D

skf-lubrication.partcommunity.com/3d-cad-models

Pump unit

P/PW/PF/PFW-289



Description

These pneumatically actuated piston pumps were designed for intermittently operated, single-line centralized lubrication systems with metering devices. The valve set required for pressure relief and limitation is included.

Features and benefits

- Electrical monitoring via external controller or SPS
- Simple handling
- Optional low-level control for reservoir
- Suitable for use with metering devices of category 1, 2 and 3

Applications

- Machine tool
- Printing machines
- Industrial assembly and automation

Technical data

Function principle	air operated piston pump (single stroke)
Outlets	1
Metering quantity	10 cm ³ /stroke, 0.61 in ³ /stroke
Working frequency	
Lubricant	mineral, synthetic, and environmentally friendly oils, operating viscosity 20 to 1500 mm ² /s or fluid grease with NLGI 000, 00
Operating temperature	+10 to +40 °C; +50 to +104 °F
Operating pressure	max. 40 bar, 580 psi
Reservoir	1.5 l, 0.4 gal
Material (reservoir)	polycarbonate
Connection outlet	6 mm, 0.24 in, OD tube
Dimensions	depending on model min. 170 × 248 × 128 mm max. 170 × 270 × 128 mm min. 6.7 × 9.8 × 5.04 in max. 6.7 × 10.6 × 5.04 in
Mounting position	vertical
Fill-level switch for monitoring the minimum fluid grease level	
Type of contact	1 change-over
Switching voltage	230 VAC; 230 VDC
Switching current	max. 230 VAC/DC: 1,0 A
Breaking capacity	max. 230 VAC: 60 VA; max. 230 VDC: 40 W
Type of enclosure	IP 65
Cable gland	PG11

Order information

Order number	Lubricant		Fill-level switch
	Oil	Fluid grease	
P-289	•	–	–
PW-289	•	–	•
PF-289	–	•	–
PFW-289	–	•	•



NOTE

Further technical information, technical drawings, accessories, spare parts or product function descriptions available on SKF.com/lubrication:
1-1110-EN, 951-170-012



3D
skf-lubrication.partcommunity.com/3d-cad-models

Pump unit

ACP



PRODUCT
AVAILABLE
IN 2021



Description

The model ACP is an air-operated compact pump unit. Featuring a compact, lightweight design, that cost-effective pump is compatible with oil and fluid grease. Constructed of robust material, the pump is reliable in demanding applications. An optional fill-level monitor with prewarning functionality helps users to take early action. Low operating pressures of up to 38 bar (551 psi) enable the use of SKF Quick Connector fittings and SKF single-line metering devices of category 1 without additional pressure regulation. The ACP pump replaces pump series POEP/PFEP.

Feature and benefits

- Simple to use
- Easy system integration
- Reliable operation
- Lightweight and robust design, compact size
- Fill-level monitoring
- Simple maintenance
- Suitable for use with metering devices of category 1

Applications

- Simple machine tool and punching/laser machinery
- Process and packaging machinery
- Material handling devices
- Textile machinery
- Chain lubrication
- Cartesian robots
- Etc.

Technical data

Function principle	air operated piston pump
Outlets	2
Metering quantity	up to 15 cm ³ /stroke up to 0.91 in ³ /stroke
Lubricant	mineral and synthetic oils with an operating viscosity of 20–1 500 mm ² /s fluid greases: NLGI 000, 00
Operating temperature	0 to +60 °C; 32 to 140 °F
Operating pressure	max. 38 bar; 551 psi
Reservoir	0,5; 1,0; 1,7 l 0.13; 0.26; 0.45 gal
Protection class	IP 54
Material (reservoir)	acrylic
Connection outlet	G ¹ / ₄ × 12 mm
Air inlet connection	G ¹ / ₄ × 12 mm
Air actuation pressure	3,5–10 bar; 50–145 psi
Dimensions	
0,5 l	124 × 108 × 251 mm; 4.89 × 4.25 × 9.88 in
1,0 l	124 × 108 × 341 mm; 4.89 × 4.25 × 13.42 in
1,7 l	124 × 108 × 451 mm; 4.89 × 4.25 × 17.75 in
Mounting position	vertical
Weight (dep. on model)	1,3–2,6 kg; 2.8–5.7 lb



NOTE

Further technical information, technical drawings, accessories, spare parts or product function descriptions available on SKF.com/lubrication.

Pump unit

ACP

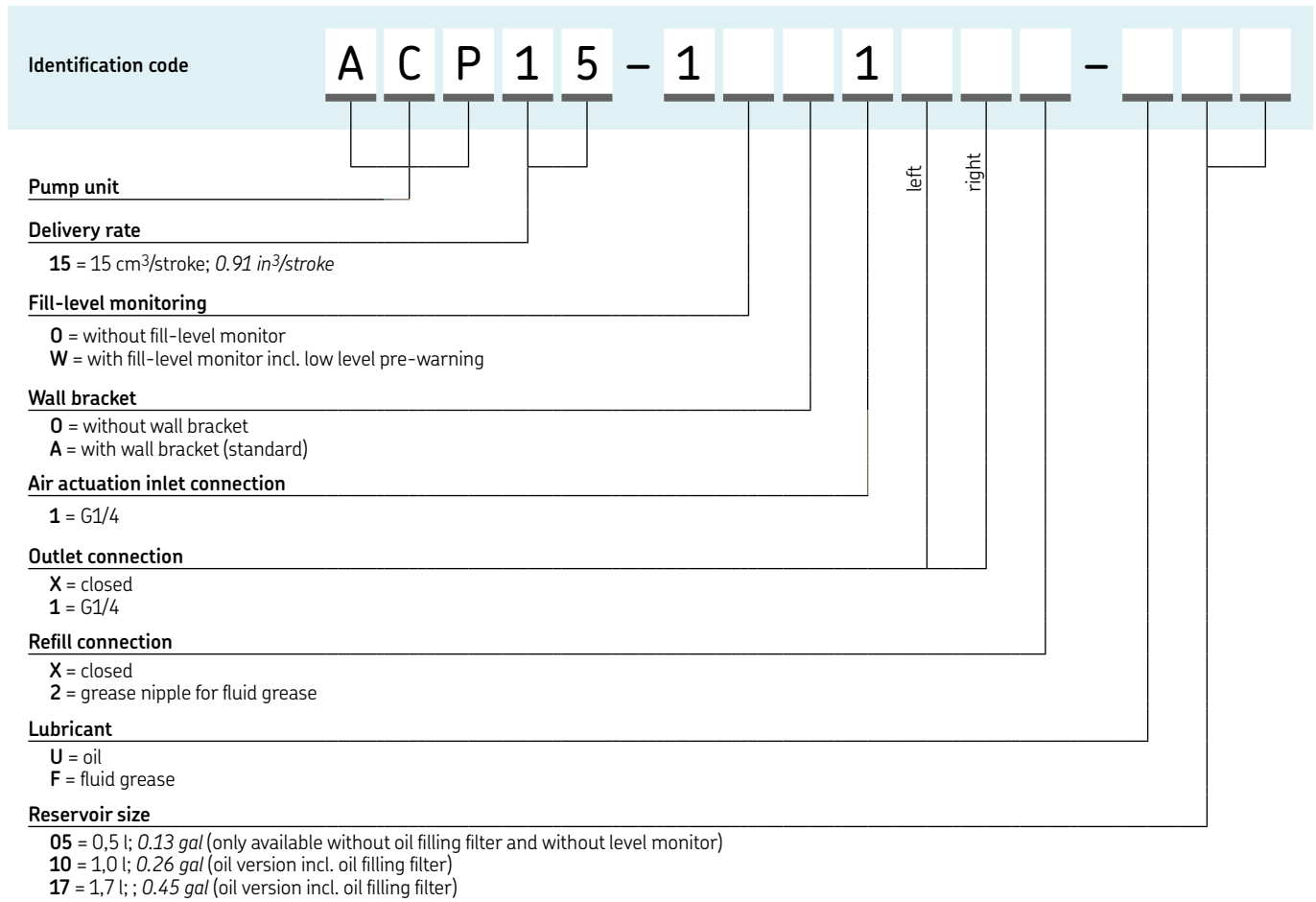

ACP standard product range

Order number	Description
ACP15-10A11X2-F05	ACP for fluid grease with 0,5 l reservoir, without fill level monitor
ACP15-10A11X2-F10	ACP for fluid grease with 1,0 l reservoir, without fill level monitor
ACP15-1WA11X2-F10	ACP for fluid grease with 1,0 l reservoir, with fill level monitor
ACP15-10A11X2-F17	ACP for fluid grease with 1,7 l reservoir, without fill level monitor
ACP15-1WA11X2-F17	ACP for fluid grease with 1,7 l reservoir, with fill level monitor
ACP15-10A11XX-U05	ACP for oil with 0,5 l reservoir, without fill level monitor
ACP15-10A11XX-U10	ACP for oil with 1,0 l reservoir, without fill level monitor
ACP15-1WA11XX-U10	ACP for oil with 1,0 l reservoir, with fill level monitor
ACP15-10A11XX-U17	ACP for oil with 1,7 l reservoir, without fill level monitor
ACP15-1WA11XX-U17	ACP for oil with 1,7 l reservoir, with fill level monitor

- Order example**
- ACP15-1WA11X2-F10
- air-operated compact pump
 - delivery rate 15 cm³/stroke
 - with fill-level monitoring
 - with wall bracket
 - G1/4 air actuation connection
 - G1/4 outlet connection left
 - closed outlet connection right
 - grease nipple refill connection
 - fluid grease version
 - reservoir 1,0 liter

Pump unit

PPS30

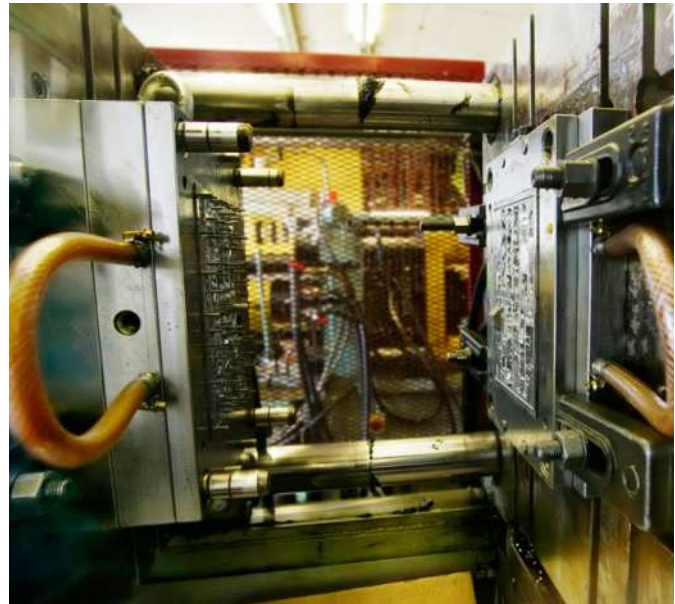

Description

Setting new standards in design, this compact unit combines proven lubrication technology with integrated functional elements. The easy-to-clean PPS30 features an integrated relief valve and electronic sensors, as well as a central opening for easy filling from all sides. In addition to low investment costs, it offers very low operating costs due to minimal compressed air consumption. The lightweight unit is made almost entirely of functional, high-performance plastics.

Features and benefits

- Compact, modern design with user friendly operation
- Quick and simple installation with flexible connection system
- Easy visual fill-level monitoring plus electric fill-level control
- Suitable for use with metering devices of category 1 and 2

Applications

- Machine tools
- Automation
- Packaging
- Woodworking
- Printing
- Textiles



NOTE

Further technical information, technical drawings, accessories, spare parts or product function descriptions available on SKF.com/lubrication:
1-0942-EN, 951-170-220 EN



3D

skf-lubrication.partcommunity.com/3d-cad-models

Technical data

Function principle	air operated piston pump (single stroke)
Outlets	max. 3
Metering quantity	30 cm ³ /stroke, 1.83 in ³ /stroke
Working frequency	6 strokes/h
Lubricant	mineral and synthetic oils, operating viscosity 20 to 1 500 mm ² /s or fluid grease NLGI 000, 00
Operating temperature	+10 to +50 °C; +50 to +122 °F
Operating pressure	max. 27 bar, 392 psi
Actuation pressure	4,5 to 6 bar; 65 to 87 psi
Reservoir	1,5 l, 0.39 gal
Material (reservoir)	plastic (SAN)
Connection outlet	M10×1 thread or plug connector for pipes Ø6 and Ø8 mm or banjo fitting for pipe Ø6 mm
Air inlet	M10×1 thread or plug connector for pipes Ø6 and Ø8 mm or banjo fitting for pipe Ø6 mm
Transmission ratio	4,5:1
Air valve	required 3-way, see accessories
Pressure reducing valve	required, see accessories
Dimensions	187 × 246 × 129 mm 7.3 × 9.6 × 5.1 in
Installation space	min. 230 × 300 × 250 mm min. 9 × 11.8 × 9.8 in
Mounting position	vertical

Fill-level switch for monitoring the minimum lubricant level

Function	capacitive, NC-contact
Switching voltage	10 to 36 VDC
Power consumption	max. 150 mA

Pressure switch for monitoring pressure build-up and function

Function	NO-contact
Rated pressure	16 bar, 232 psi
Electrical connection	4-pin M12 × 1 circular plug

Pump unit

PPS30

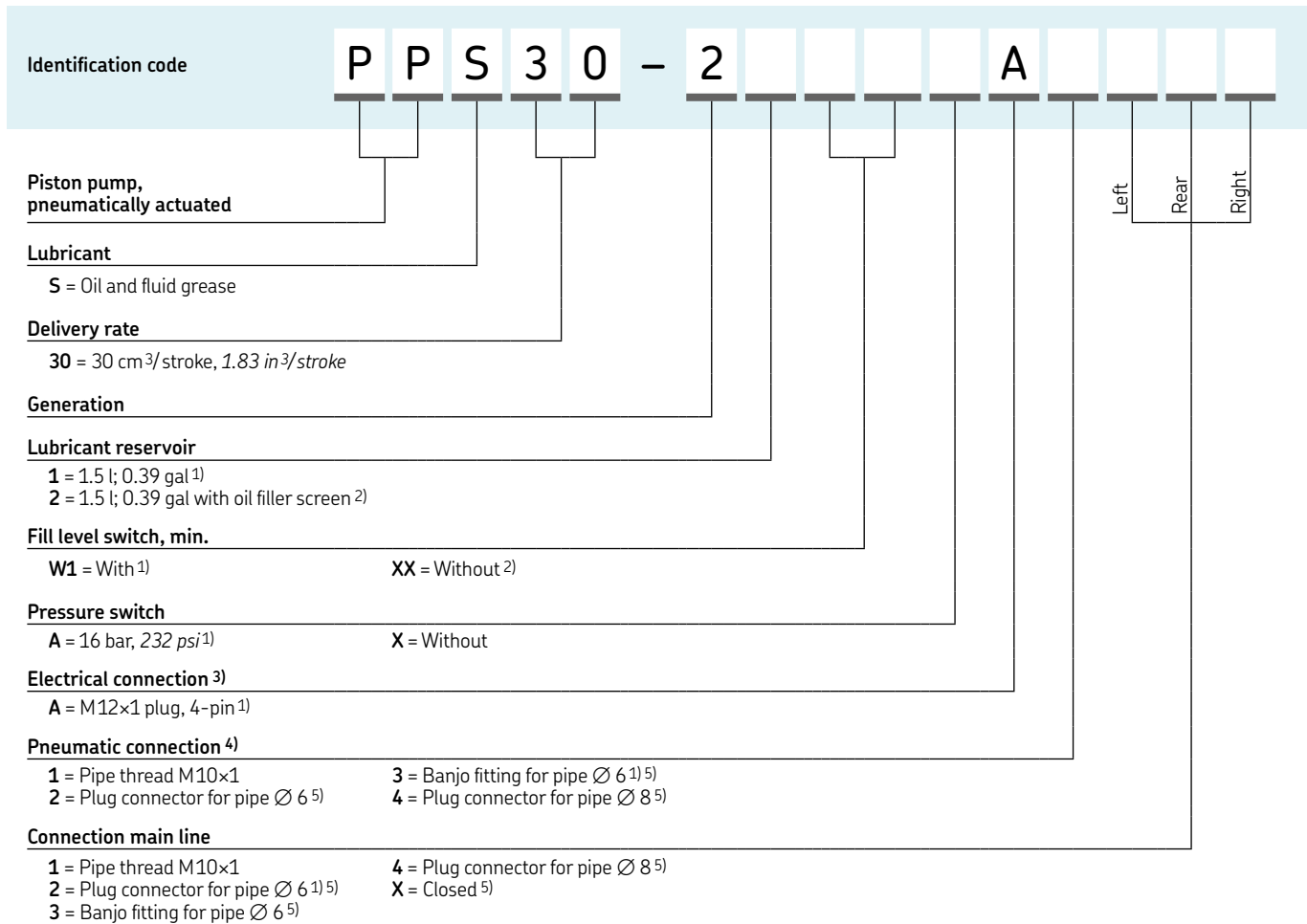

- 1) Standard design
 2) The oil filler screen option can be used only on PPS30 pumps produced after September 29, 2017.
 3) Electrical connection required if fill-level switch and/or pressure switch is selected
 4) Must select pneumatic connection
 5) For fitting order numbers → accessories

Accessories

Order number	Designation
161-120-067+924	3/2-way air inlet valve, 24 VDC
161-120-067+910	3/2-way air inlet valve, 110 VAC
995-901-063	Pressure-reducing valve
169-400-405	Oil filler screen
466-421-001	Plug connector for pipe ∅ 6; order code 2
506-140-VS / 408-004-VS	Banjo fitting for pipe ∅ 6; order code 3
995-901-063	Plug connector for pipe ∅ 8; order code 4
995-901-061	Closure plug; order code X
	Adapter plate for mounting; 214 x 48 x 10 mm, 8.4 x 1.9 x 0.4 in

Pump unit

P-886

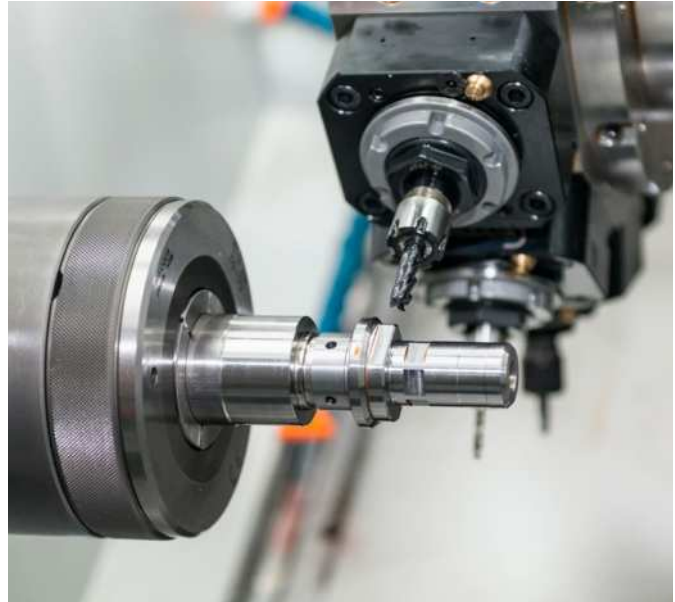

Description

Pump P-886 is a high-volume oil pump without reservoir made from metal designed for remote or bulk-fill oil applications. It discharges lubricant on the air-powered forward stroke and releases pressure on the lubricant line through included check/relief valve through a M10x1 oil outlet.

Features and benefits

- Designed for remote or bulk-fill oil applications
- Remote system components available upon request
- Suitable for use with metering devices of category 1–3

Applications

- Plastic processing
- Food and beverage
- Material handling
- Packaging

Technical data

Order number	P-886
Function principle	air or hydraulically operated piston pump
Outlets	1
Metering quantity	30 cm ³ /stroke, 1.8 in ³ /stroke
Lubricant	mineral or synthetic oils, compliant with plastic, NBR-elastomers, cooper and copper alloys
Operating temperature	10 to +40 °C 50 to +104 °F
Operating pressure	max. 35 bar, max. 508 psi
Actuation pressure	4–10 bar, 58–145 psi
Reservoir	external
Connection outlet	M14×1,5 (for tube Ø8 mm)
Connection inlet	M16×1,5 (for tube Ø10 mm)
Air inlet connection	G1/4 (for tube Ø8 mm)
Return valve connection outlet	M10×1 (for tube Ø6 mm)
Protection class	IP 54
Dimensions	108 × 219 × 108 mm 4.25 × 8.62 × 4.25 in
Mounting position	any



NOTE

Further technical information, technical drawings, accessories, spare parts or product function descriptions available on [SKF.com/lubrication](https://www.skf.com/lubrication).

Pump unit

82676



Description

Pump model 82676 is a high-volume pump designed for remote or bulk-fill oil applications. It discharges lubricant on the air-powered forward stroke and releases pressure on the lubricant line through included check/relief valve through a 1/2 NPTF (F) oil outlet. (head pressure max. 5,5 bar; 80 psi)

Features and benefits

- Designed for remote or bulk-fill oil applications
- Remote system components available upon request
- Suitable for use with metering devices of category 4

Applications

- Steel mills
- Packaging
- Plastic processing
- Material handling
- Food and beverage



Technical data

Order number	82676
Function principle	air operated piston pump (single stroke)
Outlets	1
Metering quantity	39,3 cm ³ /stroke, 2.4 in ³ /stroke
Working frequency	
Lubricant	oil, synthetic oils on request
Operating temperature	-23 to +65 °C -10 to +150 °F
Operating pressure	max. 70 bar, 1 000 psi
Reservoir	external
Connection outlet	1/4 NPTF (F)
Transmission ratio	20:1
Air valve	required, 4-way
Dimensions	470 × 146 × 533 mm 18.5 × 5.75 × 21 in
Mounting position	vertical



NOTE

Further technical information, technical drawings, accessories, spare parts or product function descriptions available on SKF.com/lubrication.

Pump unit

82570



Description

Pump model 82570 is a high-volume pump that discharges lubricant on the air-powered forward stroke and releases pressure on the lubricant line through included check/relief valve on the air-powered return stroke. Its acrylic reservoir is refilled through the filler cap with strainer.

Features and benefits

- Reservoir with filler cap and internal strainer
- Remote system components available upon request
- Suitable for use with metering devices of category 2, 3 and 4

Applications

- Textiles
- Steel mills
- Packaging
- Plastic processing
- Material handling
- Food and beverage

Technical data

Order number	82570
Function principle	air operated piston pump (single stroke)
Outlets	1
Metering quantity	39,3 cm ³ /stroke, 2.4 in ³ /stroke
Working frequency	
Lubricant	oil, synthetic oils on request
Operating temperature	-23 to +65 °C -10 to +150 °F
Operating pressure	max. 70 bar, 1 000 psi
Reservoir	2,0 l, 0.5 gal
Reservoir material	acrylic
Connection outlet	1/4 NPTF (F)
Transmission ratio	20:1
Air valve	required, 4-way
Dimensions	451 × 146 × 464 mm 17.75 × 5.75 × 18.25 in
Mounting position	vertical



NOTE

Further technical information, technical drawings, accessories, spare parts or product function descriptions available on SKF.com/lubrication.

Pump unit

85430/31/32/33



Description

These air-operated, positive displacement pumps deliver maximum volume via a single stroke of the pump. Solenoid air valves and adjustable, solid-state time controls are integrated into the pump body. All pumps are designed to deliver fluid lubricants to single-line metering devices and are filled via a spring-loaded filler cap and internal filter. Acrylic reservoirs are available in several sizes. Pump models 85432 and 85433 do not include a reservoir and are designed for remote or bulk-fill oil applications.

Features and benefits

- Reservoir with filler cap and internal strainer
- Integrated, adjustable solid-state time controls with LED indicators
- Integrated solenoid air valves
- Suitable for use with metering devices of category 2, 3 and 4 (85432, 85433 are only suitable for use with category 4)

Applications

- Closing machines
- Packaging machines, material handling
- Plastic processing, tire presses

Technical data

Function principle	air operated piston pump (single stroke)
Outlets	1
Metering quantity	39,3 cm ³ /stroke, 2.4 in ³ /stroke
Working frequency	
Lubricant	oil, synthetic oils on request
Operating temperature	-23 to +65 °C; -10 to +150 °F
Operating pressure	max. 70 bar, 1 000 psi
Reservoir	85430, 85431 only: 2 l, 0.5 gal
Material (reservoir)	acrylic
Connection outlet	1/4 NPTF (F)
Voltage	120 VAC; 240 VAC
Transmission ratio	20:1
Dimensions	627 × 166 × 460 mm 24.7 × 5.52 × 18.11 in
Mounting position	vertical
Timer and controller	
On time	10 or 30 sec
Off time	30 sec to 30 min. or 30 min. to 30 h
Alarm contacts	8 A at 250 VAC
Operating temperature	-23 to +65 °C -10 to +150 °F

Order information

Order number	Voltage	Reservoir	
	VAC	l	gal
85430	120	2,0	0,5
85431	240	2,0	0,5
85432	120	-	-
85433	240	-	-



NOTE

Further technical information, technical drawings, accessories, spare parts or product function descriptions available on SKF.com/lubrication.

Pump unit

PEF/PEU



Description

These pneumatically actuated piston pumps were designed for intermittently operated, single-line centralized lubrication systems with metering devices. The valve set required for pressure relief and limitation is included.

Features and benefits

- Driven by on-board compressed air system
- Optional integrated control
- Electrical monitoring via external controller or SPS
- Simple handling
- Suitable for use with metering devices of category 1, 2 and 3

Applications

- Vehicles and trailer
- Machine tools
- Printing machines
- Industrial assembly and automation

Order information			
Order number	Lubricant		Fill-level switch
	Oil	Fluid grease	
PEF-90	•	•	•
PEF-99W	–	•	•
PEF-99W-S1	–	•	•
PEF-99W-S2	–	•	•
PEF-99W-S3	–	•	–
PEU-99	•	•	–
PEU-99-S2	•	•	–
PEU-99-S3	•	–	–

Technical data

Function principle	air operated piston pump
Outlets	1
Metering quantity	48 or 50 cm ³ /stroke 2.93 or 3.05 in ³ /stroke
Working frequency	
Lubricant	mineral, synthetic, and environmentally compatible oils, operating viscosity 20 to 1 500 mm ² /s or fluid grease, NLGI 000, 00
Operating temperature	–25 to +80 °C; –13 to +176 °F
Operating pressure	max. 50 bar, 725 psi
Reservoir	3,0 l, 0.8 gal
Material (reservoir)	polycarbonate
Connection outlet	M16 × 1,5
Dimensions	
PEF-90	248 × 194 × 341 mm 9.8 × 7.6 × 13.4 in
PEF-99W	270 × 126 × 355 mm 10.6 × 4.9 × 13.9 in
PEU-99	270 × 126 × 355 mm 10.6 × 4.9 × 13.9 in
Mounting position	vertical

Fill-level switch for monitoring the minimum grease level

Type of contact	NO-contact
Switching voltage	max. 10 to 35 VDC
Output current	400 mA
Capacity	15 mA
Type of enclosure	IP 54

NOTE

Further technical information, technical drawings, accessories, spare parts or product function descriptions available on SKF.com/lubrication:

1-1110-EN, 951-170-012 EN



3D

skf-lubrication.partcommunity.com/3d-cad-models

Pump unit

1826



Description

Pump model 1826 is modular assembled and consists of air motor, attached pump tube, vent valve assembly, drum cover, controller, lubricant connecting hoses and safety unloader. Modular structured air motor is fully pneumatically monitored. Supplied compressed air to air motor moves oscillating piston in cylinder up and down. Simultaneously outlet air pours out of opposite cylinder chamber via exhausting baffle. A signal valve operates as a sensor and forwards pneumatic signal pressure to a relay valve as soon as piston has reached its fully stroke in one direction. Relay valve now switches pneumatically movement of piston opposite. Oscillation operation is working. Pumps consist in two devices, air motor and pump tube with integrated shovel piston. Oscillation piston initiates shovel piston to pump operation by sucking and pumping function. Pumps are supplied in moduls must be furnished on side of user but can also supplied completely on request.

Features and benefits

- Midsize volume PowerMaster air motor
- Carbon steel pump tube with shovel-foot design, selected fit plunger and bushing
- Vent valve assembly and safety unloader included
- Drum cover for standard U.S. 55 gal. (200 l) drums (removable head)
- Simplified, modular design
- Wear-resistant and robust construction, reliable
- Suitable for use with metering devices of category 2, 3 and 4

Applications

- Steel mills
- Plastic processing
- Food and beverage
- Glass industry
- Material handling



Technical data

Order number	1826
Function principle	air operated reciprocating piston pump
Outlets	1
Metering quantity	7 571 cm ³ /min, 462 in ³ /min
Lubricant	oil
Pump tube 84991	
Volume/cycle (up and down)	100 cm ³ ; 6.10 in ³
Max. pump cycles/minute	70 permitted
Operating temperature	-34 to +93 °C -29 to +199 °F
Operating pressure	max. 70 bar; 1 000 psi
Air inlet	3/8 NPTF (F)
Connection outlet	3/4 NPTF (F)
Transmission ratio	24:1
Dimensions	
Total length	1 464 mm; 57.64 in
Immersion length	864 mm; 34.01 in
Mounting position	vertical
Controller	
Voltage	110 VAC, 50 Hz; 120 VAC, 60 Hz



NOTE

Further technical information, technical drawings, accessories, spare parts or product function descriptions available on SKF.com/lubrication.

Pump unit

ECP



Description

The Electric Cartridge Pump ECP was developed to lubricate bearings and linear guides in small machines. It includes an integrated pressure-relief. This electrically driven piston pump uses 24 VDC and is controlled by an external programmable logic controller (PLC) for convenience. In addition, the pump is capable of manually activating a lubrication cycle and can be used with an optional, integrated level switch to monitor the oil level of the cartridge. Utilizing easy-to-exchange cartridges, it is compatible with oil viscosities from 20 to 1 500 mm²/s and fluid grease grades of NLGI 00 and 000.

Features and benefits

- Cost effective solution
- Simple to operate
- Increases reliability
- Minimizes risk of using wrong or contaminated lubricant
- Reduces unplanned downtime
- Extends maintenance intervals
- Minimizes environmental impact via efficient use of lubricants

Applications

- Automation
- Machine tools
- Material handling
- Plastic processing
- Food and beverage



Technical data

Function principle	electrically operated piston pump
Outlets	2
Metering quantity	fluid grease: 12 cm ³ /min; 0.73 in ³ /min oil: 0.012 l/min; 0.0027 gal/min
Lubricant	oil: 20 to 1 500 mm ² /s fluid grease: NLGI 00, 000
Operating temperature	+10 to +50 °C; +50 to +122 °F
Operating pressure	max. 38 bar; 550 psi
Reservoir	prefilled cartridge 380 ml; 12.8 l. oz. or fixed reservoir 0,5; 1,0 or 1,7 l; 1.06; 2.1; 3.6 pt
Outlet connection	M10×1 thread or SKF Quick Connector 6–8 mm
Operating voltage	24 VDC
Dimensions	without cartridge: 143×172×121 mm 5.63×6.77×4.76 in with cartridge: 307,5×172×121 mm 12.1×6.77×4.76 in with fixed reservoir: min. 240×239×210 mm min 9.45×9.40×8.27 in max. 240×439×210 mm min 9.45×17.28×8.27 in
Mounting position	upright



NOTE

Further technical information, technical drawings, accessories, spare parts or product function descriptions available on SKF.com/lubrication:

16966 EN, 951-170-232



3D

skf-lubrication.partcommunity.com/3d-cad-models

Pump unit

ECP

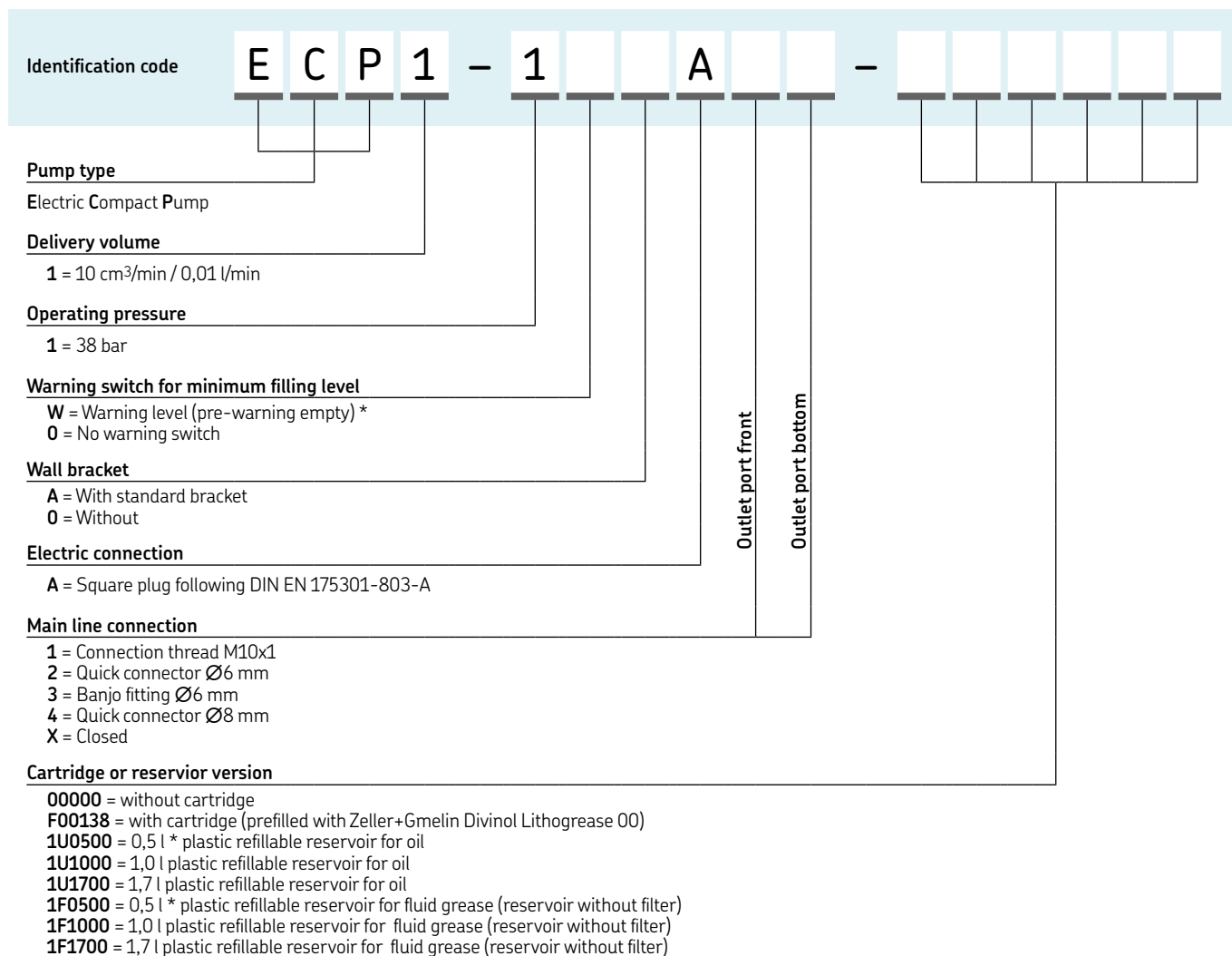

* NOTE: The 0,5 liter version can not be ordered with warning switch and/or oil filling filter.

Accessories

Pre-filled standard cartridge, 380 ml		Electrical connectors	
Lubricant	Package Order code	Rectangular connectors acc. to DIN EN175301-803-A	179-990-033 / -147
Zeller Gmelin Divinol Lithogrease 00	10 pcs LF001/MR380	Circular plug M12x1, straight acc. to DIN EN61076-2-101	179-990-371 / -381
Main line connectors		Circular plug M12x1, angled acc. to DIN EN61076-2-101	179-990-372 / -382
Connection thread M10x1	898-110-120	Wall bracket	995-901-065
Quick connector Ø6 mm	406-004-VS	Spare parts kit of gasket, adhesive	541-34901-5
Banjo fitting Ø6 mm	506-140-VS	Closure screw (ECP cartridge port)	541-34901-4
Quick connector Ø8 mm	408-0074-VS	Pressure-relief valves 60 bar for use in main line	
Closing plug	466-431-001	Pressure-relief valve Ø6 mm	451-006-060
		Pressure-relief valve Ø8 mm	451-008-060

Pump unit

P 653S (oil)

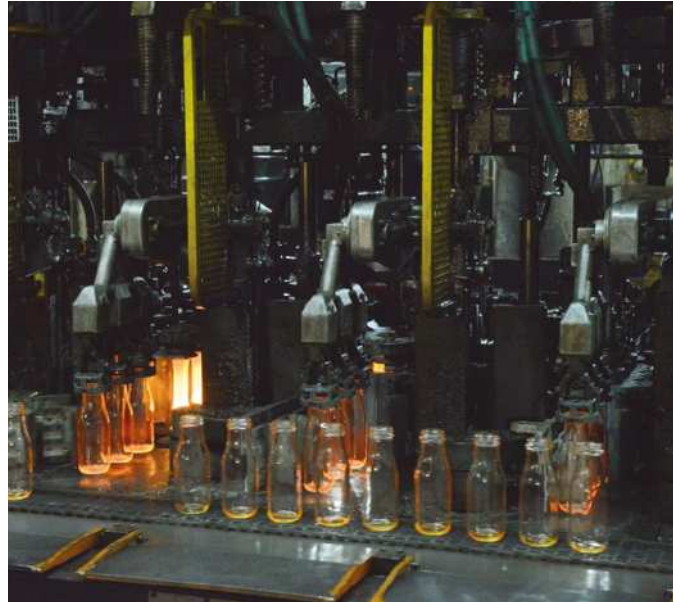

Description

Suitable for multiple applications, the Lincoln P 653S electrically driven oil pump simplifies the design of your lubrication system and delivers significant flexibility. A member of the Centro-Matic family, the pump comes complete with a reservoir, pressure switch/transducer, vent valve and controller in one compact unit.

Features and benefits

- Integration of major system components reduces labor and overall costs
- Simplifies lubrication system design
- Reduces installation time via “plug-and-go” capability
- Minimizes lubricant consumption by running only when the machine is operating

Applications

- Automation
- Machine tools
- Glass manufacturing plants
- Woodworking facilities
- Oil and Gas plants
- Steel plants

NOTE



Further technical information, technical drawings, accessories, spare parts or product function descriptions available on SKF.com/lubrication:

16072 EN



3D

skf-lubrication.partcommunity.com/3d-cad-models

Technical data

Function principle	electrically operated piston pump
Outlets	1
Metering quantity	24,6 cm ³ /min, 1.5 in ³ /min
Lubricant	oil, minimum 40 mm ² /s (cST)
Operating temperature	0 to +50 °C; +32 to +122 °F
Operating pressure	with pressure switch: 240 bar, 3 500 psi with pressure transducer: factory preset to 82 bar, 1 200 psi
Reservoir	4 l, 1 gal; 8 l, 2 gal
Material (reservoir)	thermoplastic
Connection outlet	G 1/4
Incoming voltage	120/230 VAC ¹⁾
Current	max. 1,7 A
Frequency	47 to 63 Hz
Pause time	max. 59 h, 59 min min. 4 min
Pause time increments	1 hr or 1 min
Pumping time	max. 12 min
Dimensions	depending on model min. 240 × 467 × 235 mm max. 240 × 508 × 235 mm min. 9.5 × 18.4 × 9.25 in max. 9.5 × 20 × 9.25 in
Mounting position	upright
Pump elements	
Piston	∅ 7 mm, 0.3 in
Number connected	3
Protection	1P 6K9K

¹⁾ 24 VDC version available on request.

Pump unit

P 653S (oil)

Order information

Order number	120/230 VAC 50/60 Hz	Reservoir capacity		Internal pressure switch	Internal pressure transducer	Internal and end-of-line pressure switch	Internal and end-of-line pressure transducer
		l	gal				
80127	•	4	1	•	•	–	–
80128	•	8	2	•	•	–	–

Pump unit

KFB



Description

Used with SKF single-line systems, the KFB series gear pump units supply fluid grease NLGI 000 and 00 and include a pressure-relief valve and a pressure-limiting valve. The pumps are designed for supply voltages of 12 VDC and 24 VDC and are controlled either by an integrated electronic control unit or externally, via the machine control system. Depending on the design, the gear pump units are filled via a filler socket or attached filler coupling.

Features and benefits

- Compact pump unit
- Integrated pressure-relief valve and pressure-regulating valve
- Visual or optional electrical fill-level monitoring
- Optional integrated control
- Optional pre-assembled lubrication distributor of VN series

Applications

- Commercial vehicles
- Industrial applications



Technical data

Function principle	electrically operated gear pump
Outlets	1
Metering quantity ¹⁾	50 cm ³ /min, 3.05 in ³ /min
Lubricant	fluid grease of NLGI 000 or 00
Operating temperature	-25 to +75 °C; -13 to +167 °F
Operating pressure	max. 38 bar, 550 psi
Reservoir	KFB(S)1-W: 1 l, 0.26 gal KFB(S)1: 1.4 l, 0.37 gal
Material (reservoir)	translucent plastic
Connection outlet	Ø 10 × 1.5 (max. 16 m, 52.5 ft)
Dimensions:	
KFB(S)1, KFB(S)1-W	216 × 150 × 235 mm 8.5 × 5.9 × 9.3 in
KFB(S)1-4-S1, KFB(S)1-W-4-S1, KFB(S)1-6-S1, KFB(S)1-W-6-S1	245 × 150 × 294 mm 9.6 × 5.9 × 11.6 in
Mounting position	vertical
DC motor	
Voltage	12, 24 VDC
Current	3,8 A; 1,7 A
Rated output	46 W, 41 W
Protection class	IP 6K6K / IP 6K9K

¹⁾ At back pressure of 10 bar (145 psi) and a temperature of +25 °C (+77 °F)

NOTE

Further technical information, technical drawings, accessories, spare parts or product function descriptions available on SKF.com/lubrication:

1-1206-EN, 951-170-009 EN



3D

skf-lubrication.partcommunity.com/3d-cad-models

Pump unit

KFB

Order information

Order number		Lubricant Fluid grease NLGI 000, 00	Control unit	Fill-level switch	Electrical connections Circular connector AMP, 4-pin	Circular connector AMP, 7-pin	Operating voltage	Design
KFB1+924	¹⁾	•	–	–	•	–	24 V DC	Basic version
KFB1-W+924	¹⁾	•	–	•	–	•	24 V DC	Basic version
KFBS1+924	¹⁾	•	•	–	–	•	24 V DC	Basic version
KFBS1-W+924	¹⁾	•	•	•	–	•	24 V DC	Basic version
KFB1-4-S1+924	¹⁾	•	–	–	•	–	24 V DC	VN metering device, 4-outlets
KFBS1-4-S1+924	¹⁾	•	•	–	–	•	24 V DC	VN metering device, 4-outlets
KFB1-6-S1+924	¹⁾	•	–	–	•	–	24 V DC	VN metering device, 6-outlets
KFBS1-6-S1+924	¹⁾	•	•	–	–	•	24 V DC	VN metering device, 6-outlets
KFB1-W-4-S1+924	¹⁾	•	–	•	–	•	24 V DC	VN metering device, 4-outlets
KFBS1-W-4-S1+924	¹⁾	•	•	•	–	•	24 V DC	VN metering device, 4-outlets
KFB1-W-6-S1+924	¹⁾	•	–	•	–	•	24 V DC	VN metering device, 6-outlets
KFBS1-W-6-S1+924	¹⁾	•	•	•	–	•	24 V DC	VN metering device, 6-outlets
KFB1+912	¹⁾	•	–	–	•	–	12 V DC	Basic version
KFB1-W+912	¹⁾	•	–	•	–	•	12 V DC	Basic version
KFBS1+912	¹⁾	•	•	–	–	•	12 V DC	Basic version
KFBS1-W+912	¹⁾	•	•	•	–	•	12 V DC	Basic version
KFB1-4-S1+912	¹⁾	•	–	–	•	–	12 V DC	VN metering device, 4-outlets
KFBS1-4-S1+912	¹⁾	•	•	–	–	•	12 V DC	VN metering device, 4-outlets
KFB1-6-S1+912	¹⁾	•	–	–	•	–	12 V DC	VN metering device, 6-outlets
KFBS1-6-S1+912	¹⁾	•	•	–	–	•	12 V DC	VN metering device, 6-outlets
KFB1-W-4-S1+912	¹⁾	•	–	•	–	•	12 V DC	VN metering device, 4-outlets
KFBS1-W-4-S1+912	¹⁾	•	•	•	–	•	12 V DC	VN metering device, 4-outlets
KFB1-W-6-S1+912	¹⁾	•	–	•	–	•	12 V DC	VN metering device, 6-outlets
KFBS1-W-6-S1+912	¹⁾	•	•	•	–	•	12 V DC	VN metering device, 6-outlets

¹⁾ All units for vehicle applications have type approval pursuant to ECE-R10.

Additional technical data for KFB(S)1, KFB(S)1-W, KFB(S)1-4-S1, KFB(S)1-W-4-S1, KFB(S)1-6-S1, KFB(S)1-W-6-S1

Fill-level switch (for KFB(S)1-W) opens when fill level too low

Switching voltage	10 to 36 V DC
Switching current	Resistive load ¹⁾ : ≤0.5 A
Switching capacity	Resistive load ¹⁾ : ≤12 W

Relubrication metering device VN (KFB(S)1(-W)4-S1, KFB(S)1(-W)6-S1)

Lubrication point connection	Push-to-connect fitting for tube Ø 4 mm
Metering quantity	0.1; 0.2; 0.4 cm ³
Feeder body material	Die-cast zinc, black corrosion protection

Control unit IG502-2-I (KFBS1)

Interval, adjustable	0.1 ... 99.9 h
Pump run time, adjustable	0.1 ... 99.9 min
Max. pump run time	3.0 min ²⁾
Elapsed-hours counter	0 ... 99999.9 h
Fault-hours counter	0 ... 99999.9 h

Additional input power for units with control unit (without output load)	4 W
-----------------------------------------------------------------------------	-----

¹⁾ When switching inductive loads, take appropriate measures to protect contacts

²⁾ The operating mode S3 (periodic duty) describes the ratio of pump run time to subsequent down time. If the relative ON-time is 2.5% and the duty cycle time is 10 to 120 min., then the limit values are as follows:

Min. duty cycle time: 10 min × 0.025 = 0.25 min. pump run time with subsequent down time of 9.75 min.

Max. duty cycle time: 120 min × 0.025 = 3 min. pump run time with subsequent down time of 117 min.

Pump unit

KFB-M



Description

Used with SKF MonoFlex single-line systems, the KFB series gear pump units supply fluid grease NLGI 000 and 00 and include a pressure-relief valve and a pressure-limiting valve. The pumps are designed for supply voltages of 24 VDC and are controlled either by an integrated electronic control unit or externally, via the machine control system. Depending on the design, the gear pump units are filled via a filler socket or attached filler coupling.

Features and benefits

- Compact pump unit
- Integrated pressure-relief valve and pressure-regulating valve
- Visual or optional electrical fill-level monitoring
- Optional integrated control

Applications

- Automation
- Automotive
- Machine tools



NOTE

Further technical information, technical drawings, accessories, spare parts or product function descriptions available on SKF.com/lubrication:
1-1206-EN; 951-170-009



3D

skf-lubrication.partcommunity.com/3d-cad-models

Technical data

Function principle	electrically operated gear pump
Outlets	1
Metering quantity ¹⁾	50 cm ³ /min, 3.05 in ³ /min
Lubricant	fluid grease of NLGI grade 000 or 00
Operating temperature	0 to +60 °C; +32 to +140 °F
Operating pressure	max. 38 bar, 550 psi
Reservoir	KFB1-M: 1,4 l, 0.37 gal KFB(S)1-M(-W): 1 l, 0.26 gal
Material (reservoir)	translucent plastic
Connection outlet	Ø 8 x 1,25 (max. 16 m, 52.5 ft)
Dimensions:	
KFB1-M, KFB1-M-W, KFB(S)1-M, KFB(S)1-M-W	216 x 150 x 235 mm 8.5 x 5.9 x 9.3 in
KFB1-M-W-S1	216 x 150 x 270 mm 8.5 x 5.9 x 10.6 in
Mounting position	vertical
DC motor	
Voltage	24 VDC ²⁾
Current	1,7 A
Rated output	41 W
Protection class	IP 65

Fill-level switch (KFB1-M-W) (change-over contact)

Switching voltage	24 VDC ²⁾
Switching current (resistive load) ³⁾	≤0.5 A
Switching capacity (resistive load) ³⁾	≤12 W

Control unit IG502-2-I (KFB(S)1)

Interval, adjustable	0.1 ... 99.9 h
Pump run time, adjustable	0.1 ... 99.9 min
Max. pump run time	2.4 min
Elapsed-hours counter	0 ... 99999.9 h
Fault-hours counter	0 ... 99999.9 h
Additional input power for units with control unit (without output load)	4 W

¹⁾ At back pressure of 10 bar and a temperature of +25 °C; +77 °F

²⁾ Safety measures to be applied for correct operation:
Protective extra-low voltage (PELV), standards: EN 60204-1/IEC 60204-1; HD 60364-4-41/DIN EN 0100-410/IEC 60364-4-41

³⁾ When switching inductive loads, take appropriate measures to protect contacts.

Pump unit

KFB-M

Order information

Order number	Lubricant	Fluid grease NLGI 000, 00	Control unit	Fill-level switch	Electrical connections	
	Oil viscosity 50–50 000 mm ² /s				Square connector 3-pin +PE	Circular connector M12×1, 4-pin
KFB1-M+924	–	•	–	–	•	–
KFBS1-M+924	–	•	•	–	•	•
KFB1-M-W+924	–	•	–	•	•	•
KFBS1-M-W+924	–	•	•	•	•	•

Pump unit

KFU



Description

The gear pump continuously supplies lubricant to relubrication metering devices via the main line network when the pump is in operation. When the metering chambers of the metering devices are full, excess lubricant flows back into the reservoir via the safety valve. At the end of the pump running time, the pressure relief valve opens so that pressure in the main line drops to a residual pressure of 0.2 to 1.0 bar (2.9 to 14.5 psi), allowing the spring-loaded pistons of the metering devices to deliver lubricant from the metering chambers to the lubrication points.

Features and benefits

- Includes gear pump with relief valve, safety valve, DC motor, transparent lubricant reservoir, filler socket and angle bracket
- Hood protects DC motor and filler socket from contaminants
- Minimizes wear and tear
- Reduces downtime
- Lowers maintenance costs via automatic lubrication

Applications

- Agriculture
- Construction machinery
- Trucks, trailers and buses

Technical data

Function principle	electrically operated gear pump
Outlets	1
Metering quantity 1)	140 cm ³ /min, 8.5 in ³ /min
Lubricant	fluid grease, NLGI 000, 00
Operating temperature	-25 to +75 °C; -13 to +167 °F
Operating pressure	max. 38 bar, 550 psi
Reservoir	2,7 or 6 l; 0.7 or 1.6 gal
Material	steel, plastic sealings: FKM, NBR reservoir: translucent plastic
Main connection	Mainly plastic tubing Ø 10 x 1.5 but also steel tubing Ø 10 x 0.7 hose SLH10-...
Secondary connection	Mainly plastic tubing Ø 4 x 0.85; in case of large movement between lubrication point and chassis: hose 734 ...
Operating voltage	12 or 24 VDC
Protection class	IP 59k
Dimensions	min. 268 x 154 x 325 mm max. 343 x 184 x 364 mm min. 10.5 x 6 x 12.7 in max. 13.5 x 7.2 x 14.3 in
Mounting position	vertical

1) At back pressure 38 bar (550 psi) and temperature +25 °C (+77 °F)

NOTE

Further technical information, technical drawings, accessories, spare parts or product function descriptions available on SKF.com/lubrication:
1-9420-EN, 951-170-006_EN



3D
skf-lubrication.partcommunity.com/3d-cad-models

Pump unit

KFU

Order information

Order number	Reservoir		Operating voltage	
	l	gal	VDC	Amp
KFU2-40+912	2,7	0.71	12	7.5
KFU2-40+924	2,7	0.71	24	7.5
KFU6-20+912 ¹⁾	6	1.6	12	7.5
KFU6-20+924 ¹⁾	6	1.6	24	7.5
KFUS2-64+912	2,7	0.71	12	16
KFUS2-64+924	2,7	0.71	24	8

¹⁾ This unit should only be used for systems with a minimum lubricant consumption of 6 l (1.6 gal) per year.

Pump unit

MKU



Description

MKU gear pump units are used in single-line systems and include a pre-installed pressure-regulating valve and pressure-relief valve. These units can be supplied with an optional pressure gauge for visual monitoring of pressure changes in the main line. Electrical pressure monitoring is performed by an integrated pressure switch, and fill-level monitoring also is possible. The pump units are controlled externally via the machine control system or an integrated control unit. Also, MKU units can be supplied with a pushbutton to activate interim lubrication at any time. Main functions are integrated into the lid, and a plastic cap protects the electrical components from contaminants such as dirt and dust.

Features and benefits

- Integrated pressure limitation and pressure relief valve
- Optional: electrical pressure switch, pressure gauge, float switch
- External control via SPS or by means of internal control unit possible
- All important functions integrated into the lid
- Modular construction

Applications

- Material handling
- Automotive
- Machine tool
- Printing and finishing
- Industrial assembly and automation
- Textiles

Technical data

Function principle	electrically operated gear pump
Metering quantity	100; 200; 500 cm ³ /min 6; 12; 31 in ³ /min
Lubricant	mineral oil or synthetic oil, 20 to 1 500 mm ² /s
Operating temperature	+10 to +40 °C +50 to +104 °F
Operating pressure	max. 30 bar, 435 psi
Reservoir	2,0; 3,0 and 6,0 l 0,5, 0,8 and 1,6 gal
Material (reservoir)	plastic, metal
Connection outlet	G 1/4
Operating voltage	24 VDC; 115 VAC; 230 VAC
Protection class	IP 54
Dimensions:	
pump unit with	
2 l; 0,5 gal plastic reservoir	204 × 130 × 298 mm 8 × 5,2 × 11,7 in
3 l; 0,8 gal plastic reservoir	286 × 132 × 298 mm 11,3 × 5,2 × 11,7 in
3 l; 0,8 gal metal reservoir	286 × 132 × 313 mm 11,3 × 5,2 × 12,3 in
6 l; 1,5 gal plastic reservoir	290 × 178 × 334 mm 11,4 × 7 × 13,2 in
Mounting position	vertical

NOTE

Further technical information, technical drawings, accessories, spare parts or product function descriptions available on SKF.com/lubrication:
1-1203-EN, 951-170-005 EN



3D
skf-lubrication.partcommunity.com/3d-cad-models

Pump unit

MKU

Identification code: **M K U - 1** [] [] [] [] [] [] [] [] **0 0 0 +** [] [] []

Product series MKx
Lubricant
 U = Oil

Delivery rate

1 = 0.1 l/min	•	•	•	-
2 = 0.2 l/min	-	•	•	•
5 = 0.5 l/min	-	•	•	•

Lubricant reservoir, control

Lubricant reservoir	1	2	3	4
	2 l, plastic	3 l, plastic	3 l, metal	6 l, plastic
Control				
A = No control, with terminal strip	•	•	•	•
B = No control, with terminal strip and push button	•	•	•	•
C = IG38-30-1 ¹⁾	-	•	•	•
D = IZ38-30-1 ¹⁾	-	•	•	•
E = IGZ36-20-S6-1 ¹⁾²⁾	-	•	•	•

Monitoring

	X	A	B	C	D	E
Fill-level switch						
Without fill-level switch	•	•	-	-	-	-
NC contact (detection of wire breakage)	-	-	•	•	-	-
NO contact (no detection of wire breakage)	-	-	-	-	•	•
Pressure switch 20 bar						
Without pressure switch	•	-	•	-	•	-
NO contact	-	•	-	•	-	•

Code number for delivery rate
Selected code number for lubricant reservoir
Selected code letter for control
Selected code letter for monitoring
Selected code number for pressure gauge
Selected code number for electrical connection

Voltage key

	Voltage	Frequency	Control
924 ³⁾	24 V DC	-	A, B, E
428	230 V AC	50/60 Hz	A, B, C, D, E
429	115 V AC	50/60 Hz	A, B, C, D, E

³⁾ Only possible with delivery rates 0.1 and 0.2 l/min

Electrical connection

Control	A	B	A,B	C	D	E
Monitoring	X	A	B	C	D	E
Electrical connection						
0 = 2 cable fittings	-	•	•	•	•	-
1 = 1 cable fitting; 1 rectangular connector	-	•	•	•	•	•
2 = 1 circular connector M12x1; 1 rectangular connector ⁴⁾	-	•	•	•	•	-
3 = 1 sealing plug; 1 cable fitting	•	-	-	-	-	-
4 = 1 sealing plug; 1 rectangular connector	•	-	-	-	-	-

⁴⁾ Only for design without control.

Pressure gauge

0 = without pressure gauge
 1 = with pressure gauge

Order example

MKU1-11AC10000+924

- Gear pump unit for oil
- Delivery rate 0.1 l/min
- 1st generation
- 2 l plastic reservoir
- No control, with terminal strip
- NC fill-level switch,
- NO pressure switch
- With pressure gauge
- 2 cable fittings
- Voltage 24 VDC

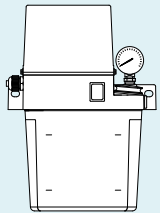

Pump unit

MKF



Description

MKF gear pump units are used in single-line systems to supply fluid greases NLGI 000 and 00 and include a pressure-regulating valve and pressure-relief valve. Electrical pressure monitoring is performed by an integrated pressure switch, and fill-level monitoring also is possible. These units are controlled externally via the machine control system or an integrated control unit. Also, MKF units can be supplied with a pushbutton to activate interim lubrication at any time. Main functions are integrated into the lid, and a plastic cap protects the electrical components from contaminants such as dirt and dust.

Features and benefits

- Integrated pressure-limitation and pressure-relief valve
- Optional: electrical pressure switch, pressure gauge, float switch
- External control via SPS or by means of internal control unit possible
- All important functions integrated into the lid
- Modular construction

Applications

- Material handling
- Automotives
- Machine tool
- Printing and finishing
- Industrial assembly and automation
- Textiles



Technical data

Function principle	electrically operated gear pump
Metering quantity	100; 200; 500 cm ³ /min 6; 12; 31 in ³ /min
Lubricant	fluid grease NLGI 000 or 00, compatible with plastics, NBR elastomers, copper and copper alloys
Operating temperature	+10 to +40 °C; +50 to +104 °F
Operating pressure	max. 30 bar, 435 psi
Reservoir	2,0; 3,0 and 6,0 l, 0,5, 0,8 and 1,6 gal
Material (reservoir)	plastic, metal
Connection outlet	G1/4
Operating voltage	24 VDC; 115 VAC; 230 VAC
Protection class	IP 54
Dimensions:	
pump unit with	
2 l; 0,5 gal plastic reservoir	204 × 130 × 298 mm 8 × 5,2 × 11,7 in
3 l; 0,8 gal plastic reservoir	286 × 132 × 298 mm 11,3 × 5,2 × 11,7 in
3 l; 0,8 gal metal reservoir	286 × 132 × 313 mm 11,3 × 5,2 × 12,3 in
6 l; 1,5 gal plastic reservoir	290 × 178 × 334 mm 11,4 × 7 × 13,2 in
Mounting position	vertical



NOTE

Further technical information, technical drawings, accessories, spare parts or product function descriptions available on SKF.com/lubrication:
1-1203-EN, 951-170-005 EN



3D

skf-lubrication.partcommunity.com/3d-cad-models

Pump unit

MKF

Identification code **M K F - 1** **0 0 0 +**

Product series MK

Lubricant
F = Fluid grease

Delivery rate

1 = 0.1 l/min	•	•	-
2 = 0.2 l/min	-	•	•

Lubricant reservoir, control

Lubricant reservoir	1	2	4
2 l, plastic			
3 l, plastic			
6 l, plastic			

Control

A = No control, with terminal strip
B = No control, with terminal strip and push button
C = IG38-30-1¹⁾
D = IZ38-30-1¹⁾
E = IGZ36-20-S6-1¹⁾²⁾

¹⁾ If control C, D or E is selected, monitoring C must be selected.
²⁾ If control E is selected, electrical connection 1 must be selected. For description of control units, see page 151.

Monitoring

	X	A	B	C
Fill-level switch				
Without fill-level switch	•	•	-	-
NC contact (detection of wire breakage)	-	-	•	•
NO contact (no detection of wire breakage)	-	-	-	-
Pressure switch 20 bar				
Without pressure switch	•	-	•	-
NO contact	-	•	-	•

Voltage key

	Voltage	Frequency	Control
924	24 V DC	-	A, B, E
428	230 V AC	50/60 Hz	A, B, C, D, E
429	115 V AC	50/60 Hz	A, B, C, D, E

Electrical connection

Control	A, B	A, B	C, D	E
Monitoring	X	A	B	C
Electrical connection				
0 = 2 cable fittings	-	•	•	•
1 = 1 cable fitting; 1 rectangular connector	-	•	•	•
2 = 1 circular connector M12x1; 1 rectangular connector ³⁾	-	•	•	-
3 = 1 sealing plug; 1 cable fitting	•	-	-	-
4 = 1 sealing plug; 1 rectangular connector	•	-	-	-

³⁾ Only for design without control.

Pressure gauge

0 = without pressure gauge
1 = with pressure gauge

Order example

MKF1-11AC10000+924

- Gear pump unit for fluid grease
- Delivery rate 0.1 l/min
- 1st generation
- 2 l plastic reservoir
- No control, with terminal strip
- NC fill-level switch, NO pressure switch
- With pressure gauge
- 2 cable fittings
- Voltage 24 VDC

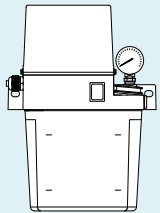

Pump unit

MFE



Description

The gear pump units comprising the MFE series are designed to supply lubricant used in intermittently operated, single-line centralized lubrication systems. The basic setup includes a gear pump unit with motor, a 3- or 6 l lubricant reservoir in metal or plastic, or a 15 l metal reservoir and float switch to monitor the minimum permissible level of lubricant. In addition to the basic models, units can be outfitted with add-ons.

Features and benefits

- Integrated float switch for fill-level monitoring
- Integrated pressure-relief valve and pressure-regulating valve
- Motors available for various voltage ranges and approvals
- Special designs offered for a wide range of applications
- Suitable for intermittent operation
- For remote installation out of reservoir or for built-in reservoir
- Reliable and versatile
- Suitable for use with metering devices of category 1 and 2

Applications

- Automotive manufacturing
- Metal, including presses
- Machine tools
- Printing and finishing
- Industrial assembly and automation

Technical data

Function principle	electrically operated gear pump
Outlets	1
Metering quantity	250 to 500 cm ³ /min, 15 to 31 in ³ /min
Lubricant	oil 5 to 2 000 mm ² /s and fluid grease NLGI 00, 000
Operating temperature	-10 to +60 °C; +14 to +140 °F
Back pressure	max. 17.5; 28 bar max. 255, 405 psi
Reservoir	3; 6; 15 l, 0.8, 1.6, 4 gal
Material (reservoir)	plastic, metal
Connection outlet	M14×1.5
Operating voltage	230/400 V AC
Protection class	IP 54
Dimensions:	
3 l; 0.8 gal plastic reservoir	303 × 130 × 245 mm; 11.9 × 5.1 × 9.6 in
3 l; 0.8 gal metal reservoir	332 × 178 × 312 mm; 13 × 7 × 12.3 in
6 l; 1.5 gal plastic reservoir	319 × 128 × 265 mm; 12.6 × 5 × 10.4 in
6 l; 1.5 gal metal reservoir	370 × 167 × 330 mm; 14.6 × 6.6 × 12.9 in
15 l; 4 gal metal reservoir	453 × 200 × 436 mm; 17.8 × 7.8 × 17.2 in
Mounting position	vertical

Floating switch for low-level monitoring of oil

Type of contact	1 change-over; 2 change-over contacts (reed contacts)
Switching voltage	max. 230 V AC, 230 V DC
Switching current	max. 0.8 A; 1.0 A
Switching capacity	max. 60 VA, 40 W ¹⁾
Type of enclosure	IP 65

¹⁾ Take appropriate measures to protect contacts when switching inductive loads

NOTE

Further technical information, technical drawings, accessories, spare parts or product function descriptions available on SKF.com/lubrication:

1-1202-EN, 951-170-002 EN



3D

skf-lubrication.partcommunity.com/3d-cad-models

Pump unit

MFE

MFE pump units for oil

Order number	Reservoir Capacity		Material	Design ¹⁾
	l	gal		
MFE5-K3-2+299	3	0.8	Plastic	CE basic version without level monitoring
MFE5-KW3-2+299	3	0.8	Plastic	CE basic version with min. fill level switch
MFE5-KW3-2-S4+299	3	0.8	Plastic	CE basic version with min. fill level switch incl. pre-warning
MFE5-KW3-S37+1FV	3	0.8	Plastic	UL/CSA version with fill level monitoring incl. min. fill level pre-warning
MFE5-KW3-S35+1FW	3	0.8	Plastic	CCC version with fill level monitoring incl. min. fill level pre-warning
MFE5-KW3-S24+MPG	3	0.8	Plastic	CE version with 6 pin Harting plug with fill level monitoring incl. min. fill level pre-warning
MFE5-K6+299	6	1.6	Plastic	CE basic version without level monitoring
MFE5-KW6+299	6	1.6	Plastic	CE basic version with min. fill level switch
MFE5-KW6-S1+299	6	1.6	Plastic	CE basic version with min. fill level switch incl. pre-warning
MFE5-KW6-S42+1FV	6	1.6	Plastic	UL/CSA version with fill level monitoring incl. min. fill level pre-warning
MFE5-KW6-S102+1FW	6	1.6	Plastic	CCC version with fill level monitoring incl. min. fill level pre-warning
MFE5-KW6-S33+MPG	6	1.6	Plastic	CE version with 6 pin Harting plug with fill level monitoring incl. min. fill level pre-warning
MFE5-B3-2+299	3	0.8	Metal	CE basic version without level monitoring
MFE5-BW3-2+299	3	0.8	Metal	CE basic version with min. fill level switch
MFE5-BW3-2-S28+299	3	0.8	Metal	CE basic version with min. fill level switch incl. pre-warning
MFE5-BW3-2-S34+1FV	3	0.8	Metal	UL/CSA version with fill level monitoring incl. min. fill level pre-warning
MFE5-BW3-S41+MPG	3	0.8	Metal	CE version with 6 pin Harting plug with fill level monitoring incl. min. fill level pre-warning
MFE5-B7+299	6	1.6	Metal	CE basic version without level monitoring
MFE5-BW7+299	6	1.6	Metal	CE basic version with min. fill level switch
MFE5-BW7-S22+1FV	6	1.6	Metal	UL/CSA version with fill level monitoring incl. min. fill level pre-warning
MFE5-BW7-S97+1FW	6	1.6	Metal	CCC version with fill level monitoring incl. min. fill level pre-warning
MFE5-BW7-S107+MPG	6	1.6	Metal	CE version with 6 pin Harting plug with fill level monitoring incl. min. fill level pre-warning
MFE5-BW7-S222+MPG	6	1.6	Metal	CE version incl. gauge and vent filter, with 6 pin Harting plug with fill level monitoring incl. min. fill level pre-warning
MFE5-BW16+299	15	4	Metal	CE basic version with min. fill level switch incl. pre-warning
MFE5-BW16-S145+1FV	15	4	Metal	UL/CSA version with fill level monitoring incl. min. fill level pre-warning
MFE5-BW16-S96+MPG	15	4	Metal	CE version with 6 pin Harting plug with fill level monitoring incl. min. fill level pre-warning
MFE5-BW16-S222+MPG	15	4	Metal	CE version incl. gauge and vent filter, with 6 pin Harting plug with fill level monitoring incl. min. fill level pre-warning
MFE5-BW30+299	30	8	Metal	CE basic version with min. fill level switch
MFE5-BW30-S30+29E	30	8	Metal	CE basic version with min. fill level switch incl. pre-warning
MFE5-BW30-S35+MPG	30	8	Metal	CE version with 6 pin Harting plug with fill level monitoring incl. min. fill level pre-warning
MFE5-BW30-S222+MPG	30	8	Metal	CE version incl. gauge and vent filter, with 6 pin Harting plug with fill level monitoring incl. min. fill level pre-warning

¹⁾ Further designs are available on request.

MFE pump units for fluid grease

Order number	Reservoir Capacity		Material	Design ¹⁾
	l	gal		
MFE2-K3-2+299	3	0.8	Plastic	CE basic version without level monitoring
MFE2-K3F-2+299	3	0.8	Plastic	CE basic version with min. fill level switch
MFE2-KW3F-S13+1FV	3	0.8	Plastic	UL/CSA version with fill level monitoring incl. min. fill level pre-warning
MFE2-KW3F-S9+MPG	3	0.8	Plastic	CE version with 6 pin Harting plug with fill level monitoring incl. min. fill level pre-warning
MFE2-K6F+299	6	1.6	Plastic	CE basic version without level monitoring
MFE2-K6F-S2+299	6	1.6	Plastic	CE basic version with min. fill level switch
MFE2-KW6F-S1+299	6	1.6	Plastic	CE basic version with min. fill level switch incl. pre-warning
MFE2-KW6F-S37+1FV	6	1.6	Plastic	UL/CSA version with fill level monitoring incl. min. fill level pre-warning
MFE2-KW6F-S41+1FW	6	1.6	Plastic	CCC version with fill level monitoring incl. min. fill level pre-warning
MFE2-KW6F-S20+MPG	6	1.6	Plastic	CE version with 6 pin Harting plug with fill level monitoring incl. min. fill level pre-warning

¹⁾ Further designs are available on request.



Overview of grease pumps and pump units

Manually operated pump units

Product	Lubricant NLGI			Metering quantity max.		Operating pressure max.		Reservoir		Metering device category ¹⁾				Piston	Page
	0	1	2	cm ³ /stroke	in ³ /stroke	bar	psi	kg	lib	4	5	6	7		
83817	•	•	•	1,6	0.09	240	3500	0,5	1	–	•	•	•	multiple stroke	52
1810	•	•	•	2,6	0.16	240	3500	2,3	5	–	•	•	•	multiple stroke	53

¹⁾ Select the recommended fittings, adjust the pump pressure within the recommended metering device pressure range

Air-operated pump units

Product	Lubricant NLGI			Metering quantity max.		Operating pressure max.		Reservoir		Metering device category ¹⁾				Piston	Page
	0	1	2	cm ³ /stroke	in ³ /stroke	bar	psi	kg	lib	4	5	6	7		
40PGA	•	•	•	40	2.44	10	145	1,7; 2; 4; 10	3.7; 4.4; 8.8; 22	–	•	•	•	single stroke	54
82886, 83886	•	•	•	7,4	0.45	240	3 500	0,5; 2,0	1; 4,4	–	•	•	•	single stroke	56
85442	•	•	•	7,4	0.45	240	3 500	0,5	1	–	•	•	•	single stroke	57
85444/45	•	•	•	7,4	0.45	240	3 500	1,8	4	–	•	•	•	single stroke	58
85434/35/36	•	•	•	18,7; 35,2	1.14; 2.15	240	3 500	2,0	4.5	–	•	•	•	single stroke	59
82653/55	•	•	•	22,9	1.39	240	3 500	2,0	4.5	–	•	•	•	single stroke	60
83800/34	•	•	•	35,2	2.15	240	3 500	2,0	4.5	–	•	•	•	single stroke	60
83167	•	•	•	197	12	240	3 500	5,0	11	–	•	•	•	reciprocating	61
83599	•	•	•	197	12	240	3 500	5,0	11	–	•	•	•	reciprocating	62

¹⁾ Select the recommended fittings, adjust the pump pressure within the recommended metering device pressure range

²⁾ Controller included or optional

Hydraulically operated pump units

Product	Lubricant NLGI			Metering quantity max.		Operating pressure max.		Reservoir		Metering device category ¹⁾				Piston	Page
	0	1	2	cm ³ /stroke	in ³ /stroke	bar	psi	kg	lib	4	5	6	7		
BPH	•	•	•	30	1.83	120	1 740	–	–	–	•	•	•	reciprocating	65
HG 1000	•	•	–	1 000	61.02	150	2 176	1,0	2.2	•	•	–	–	single stroke	63
HG 2000	•	•	–	2 000	122	150	2 176	2,0	4.4	•	•	–	–	single stroke	63
84944, 84961	•	•	•	180	11	206	3 000	30	60	–	•	•	•	reciprocating	66
84960, 84962	•	•	•	180	11	206	3 000	–	–	–	•	•	•	reciprocating	67
FlowMaster	•	•	•	737	45	206	3 000	16–180	35–400	–	•	•	•	reciprocating	68

Air-operated barrel pumps

Product	Lubricant NLGI			Metering quantity max.		Operating pressure max.		Reservoir		Metering device category ¹⁾				Piston	Page
	0	1	2	cm ³ /min	in ³ /min	bar	psi	kg	lb	4	5	6	7		
MPB	•	•	•	305	18.61	300	4 350	18; 50; 180	40; 120; 400	–	•	•	•	reciprocating	70
84050/ 85460	•	•	•	492	30	240	3 500	27	60	–	•	•	•	reciprocating	72
282288	•	•	•	492	30	240	3 500	55	120	–	•	•	•	reciprocating	73
FlowMaster	•	•	•	737	45	206	3 000	16; 27; 41; 54; 180	35; 60; 90; 120; 400	–	•	•	•	reciprocating	74

¹⁾ Select the recommended fittings, adjust the pump pressure within the recommended metering device pressure range

²⁾ Controller included or optional



Overview of grease pumps and pump units

Electrically operated pump units

Product	Lubricant NLGI			Metering quantity max.		Operating pressure max.		Reservoir		Metering device category ¹⁾				Voltage	Page	
	0	1	2	cm ³ /min	in ³ /min	bar	psi	kg	lb	4	5	6	7			
P603S	2) 3)	•	•	•	12	0.7	300	4 350	4; 8; 10; 15; 20	8.8; 18; 22; 33; 44	-	•	•	•	12/24 V DC	76
Minilube	2)	•	•	-	13	0.8	250	3 625	2	4.4	-	•	•	•	12/24 V DC	78
KFG		•	•	•	15	0.9	300	4 350	2; 4; 6; 8; 10; 12; 15; 20	4.4; 8.8; 13; 18; 22; 26; 33; 44	-	•	•	•	12/24 V DC; 90-264 V AC	80
Multilube	2)	•	•	-	16	0.976	200	2 900	4; 10	8.8; 22	-	•	•	•	24 V DC; 115/230 V AC	82
P653S	2) 3)	•	•	•	24,6	1.5	317	4 600	4; 8; 15; 20	8.8; 18; 22; 44	-	•	•	•	24 V DC; 120/230 V AC	84

1) Select the recommended fittings, adjust the pump pressure within the recommended metering device pressure range
 2) Controller included or optional
 3) Stainless steel or C5M available

Electrically operated barrel pumps

Product	Lubricant NLGI			Metering quantity max.		Operating pressure max.		Reservoir		Metering device category ¹⁾				Voltage	Page	
	0	1	2	cm ³ /min	in ³ /min	bar	psi	kg	lb	4	5	6	7			
E-PUMP		•	•	•	55	3.35	240	3 480	18, 50, 180	40; 120; 400	-	•	•	•	20-32 V DC	86
FK	2)	•	•	•	74	4.5	400	5 800	15; 30; 60	22; 66; 132	-	•	•	•	3 phase drive	88
FlowMaster		•	•	•	103	6.3	345	5 000	16; 25; 28; 35; 40; 55; 180	35; 55; 60; 78; 90; 120; 400	-	•	•	•	12/24 V DC; 120-460 V AC	90

1) Select the recommended fittings, adjust the pump pressure within the recommended metering device pressure range
 2) Controller included or optional
 3) Stainless steel or C5M available

Pump unit

83817



Description

This manual pump unit has a metal reservoir and a spring-loaded follower. The indicator pin in the pump base shows when 172 bar (2 500 psi) system operating pressure has been achieved.

Features and benefits

- Number of strokes dependent on connected lubrication points and their dosage
- Metal reservoir with spring-loaded follower also suitable for replaceable 400 g grease cartridges
- Simple handling
- Low-cost, efficient method of lubricant distribution
- Pump base with built-in check vent valve and indicator pin for visual control of max. or vent pressure
- Vents when handle is pushed all the way back
- Two different filling couplers available
- For use with metering devices of category 5, 6, 7

Applications

- Construction machinery
- Agriculture



Technical data

Order number	83817
Function principle	manually operated piston pump
Outlets	1
Metering quantity	1,6 cm ³ /stroke, 0,10 in ³ /stroke
Lubricant	grease NLGI 0, 1, 2
Operating temperature	-20 to +65 °C, -4 to +149 °F
Operating pressure	min. 82 bar, 1 200 psi max. 240 bar, 3 500 psi
Reservoir	0,5 kg, 1 lb
Material	steel, brass, copper, polyurethane, nitrile
Filling method	0,4 kg, 14,5 oz, grease cartridge/bulk fill
Connection outlet	1/8 NPTF (F)
Dimensions	387 × 127 × 141 mm 15,25 × 5 × 5,625 in
Mounting position	vertical or horizontal



NOTE

Further technical information, technical drawings, accessories, spare parts or product function descriptions available on SKF.com/lubrication.

Pump unit

1810



Description

The Model 1810 pump unit features a translucent reservoir with spring-loaded follower. The indicator pin in the pump base shows when 172 bar (2 500 psi) system operating pressure has been achieved. It can be refilled via the included fitting using the Model 81834 filler pump or other manual pumps equipped with a Model 645006 coupler.

Features and benefits

- Number of strokes dependent on connected lubrication points and their dosage
- Reservoir with spring-loaded follower
- Simple handling
- Low-cost, efficient method of lubricant distribution
- Pump base with built-in check vent valve and indicator pin for visual control of max. or vent pressure
- Releases pressure on the lubricant line when handle is pushed all the way back
- Two different filling couplers available
- For use with metering devices of category 5, 6, 7

Applications

- Construction machinery
- Agriculture

Technical data

Order number	1810
Function principle	manually operated piston pump
Outlets	1
Metering quantity	2,6 cm ³ /stroke, 0,16 in ³ /stroke
Lubricant	grease NLGI 0, 1, 2
Operating temperature	-20 to +65 °C; -4 to +149 °F
Operating pressure	min. 82 bar, 1 200 psi max. 240 bar, 3 500 psi
Reservoir	2,3 kg, 5 lb
Material	acrylic, steel, brass, copper, polyurethane, nitrile
Connection outlet	1/4 NPTF (F)
Dimensions	413 × 181 × 197 mm 16.25 × 7.125 × 7.75 in
Mounting position	vertical or horizontal



NOTE

Further technical information, technical drawings, accessories, spare parts or product function descriptions available on SKF.com/lubrication.

Pump unit

40PGA



Description

Pump Model 40PGA is a compact lubrication pump unit. The splash-proof pump operates pneumatically and can be controlled and monitored by the remote electric control unit ST-102 or ST-102P. The pump is available with a choice of different kind of reservoir sizes and materials, each featuring a spring-loaded intermediate piston. A low-level alarm is available in aluminum and steel version and pump is available with an integrated pressure switch.

Features and benefits

- Compact, air-operated lubrication pump unit for demanding conditions
- Part of a modular and modifiable system
- Splash-proof pump is offered with:
 - choice of four different reservoir sizes
 - spring-loaded, intermediate piston in reservoir
 - steel and aluminum reservoirs are equipped with low level alarm
 - optional an integrated pressure switch
- Mechanical relief valve
- Controlled and monitored by a remote timer continuously
- Safe and environmentally friendly
- For use with metering devices of category 5, 6 and 7

Applications

- Buses and trucks
- Heavy vehicles

Technical data

Function principle	air operated piston pump
Outlet	1
Metering quantity	40 cm ³ /stroke, 2.4 in ³ /stroke
Lubricant	grease NLGI 0, 1
Operating temperature	-30 to +70 °C, -22 to 158 °F
Operating pressure (air)	max. 10 bar, 145 psi
Reservoir	1,7; 2; 4 and 10 kg 3.75; 4.40; 8.82 and 22.05 lb
Material	stainless steel, plastic, steel and aluminum
Connection outlet	R 1/4 in
Operating voltage	24 V
Transmission ratio	16:1
Protection class	IP 65
Dimensions (dep. on version)	min. 270 × 320 × 180 mm max. 570 × 325 × 245 mm min. 10.63 × 12.59 × 7.0 in max. 22.44 × 12.79 × 9.65 in
Mounting position	vertical and horizontally

 NOTE

Further technical information, technical drawings, accessories, spare parts or product function descriptions available on SKF.com/lubrication:

11678 EN, 11390007_40PGA_01_EN



3D

skf-lubrication.partcommunity.com/3d-cad-models

Pump unit

40PGA

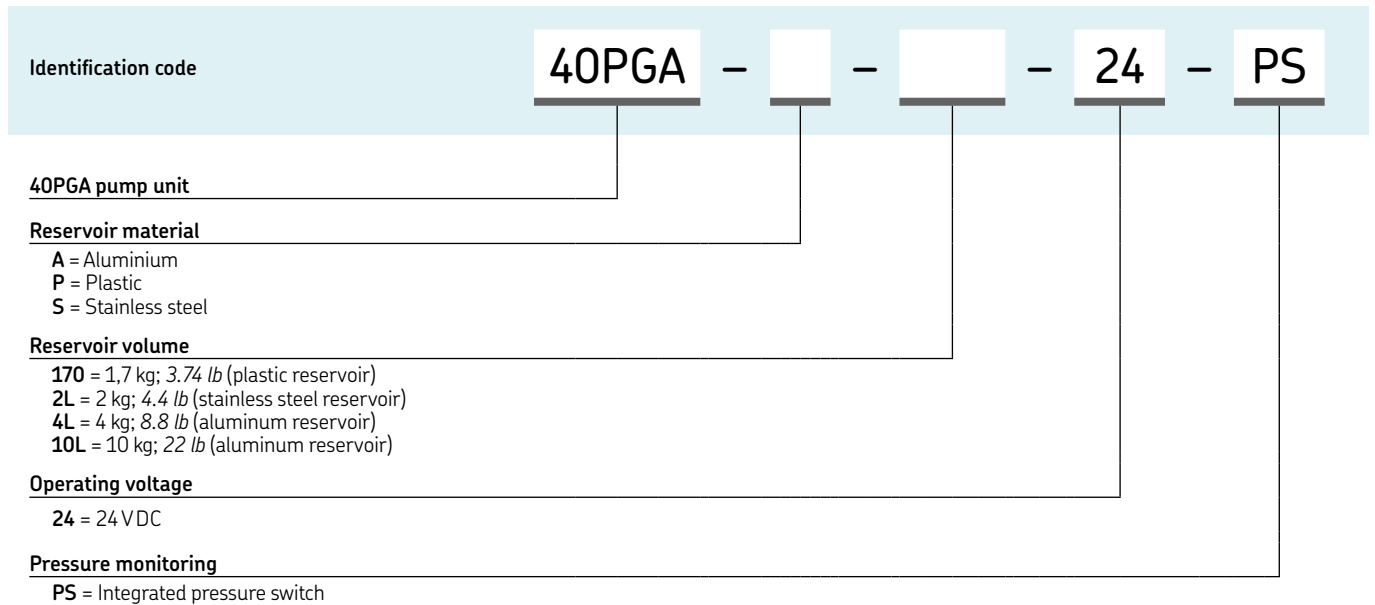

Pump unit

82886, 83668



Description

All models are air-operated, positive-displacement pumps delivering a maximum volume by means of a single stroke of the pump. Solenoid air valves and adjustable, solid-state time controls are integrated into the pump body, and translucent, acrylic reservoirs with spring-loaded followers are available in several sizes. Pump discharges lubricant on air-powered forward stroke and releases pressure on the lubricant line on spring-powered return stroke through built-in check/relief valve. Includes filler fitting for refilling reservoir with Model 81834 or other manual pump equipped with Model 645006 coupler.

Features and benefits

- Remote system components such as 3/2-way valves, adjustments for air power, and monitoring of pump and system are available separately on request
- For use with metering devices of category 5, 6 and 7

Applications

- Cement industry
- Wood-working, food and beverage

Technical data

Function principle	air operated piston pump (single-stroke)
Outlets	1
Metering quantity	7,4 cm ³ /stroke, 0,45 in ³ /stroke
Lubricant	grease NLGI 0, 1, 2
Operating temperature	-18 to +65 °C; 0 to +150 °F
Operating pressure	min. 82 bar, 1 200 psi max. 240 bar, 3 500 psi
Reservoir	0,5 or 2 kg; 1 or 4.4 lb
Material	acrylic
Connection outlet	1/4 NPTF (F)
Transmission ratio	20:1
Air inlet	1/4 NPTF (F)
Mounting position	vertical

Timer

On time	min. 10 sec; max. 1 min. 24 sec
Cycle time	min. 20 sec; max. 24 h
Voltage	120 VAC, 60 Hz; 110 VAC, 50 Hz
Operating temperature	-23 to +65 °C; -10 to +150 °F

Order information

Order number	Reservoir capacity		Dimensions	
	kg	lb	mm	in
82886	0,5	1.0	263 × 133 × 152	10.4 × 5.3 × 6.0
83668	2,0	4.4	470 × 133 × 152	18.5 × 5.3 × 6.0



NOTE

Further technical information, technical drawings, accessories, spare parts or product function descriptions available on SKF.com/lubrication.

Pump unit

85442

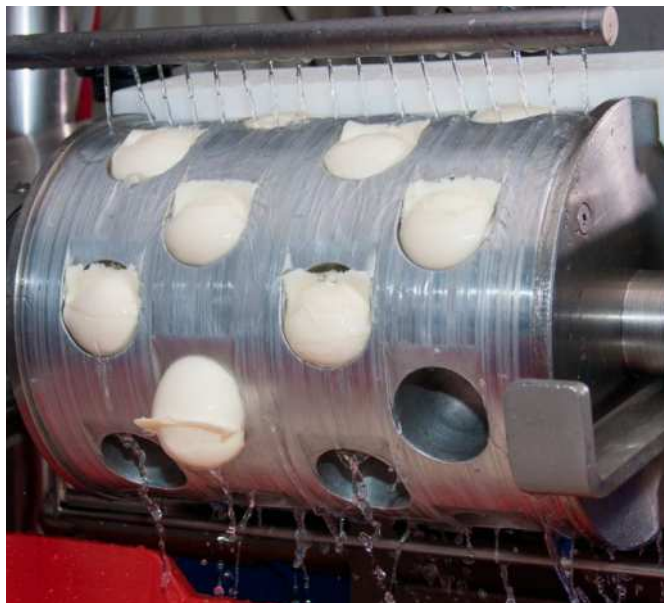

Description

Model 85442 is an air-operated, positive-displacement pump delivering a maximum volume by means of a single stroke of the pump. Solenoid air valves and adjustable, solid-state time controls are integrated into the pump body. This pump unit is designed to deliver grease to single-line metering devices and includes a special high-volume refill fitting. Acrylic reservoirs are available in several sizes. Integrated controls feature LED indicators for “Power On”, “Pump On” and “Alarm” along with a membrane-type, “Manual Lube” switch.

Features and benefits

- Reservoir 0,45 kg / 1 lb with spring-loaded follower
- Integrated solenoid air valve
- High-volume refill fitting
- For use with metering devices of category 5, 6 and 7

Applications

- Cement industry
- Wood-working
- Food and beverage

Technical data

Order number	85442
Function principle	air operated piston pump (single-stroke)
Outlets	1
Metering quantity	7,4 cm ³ /stroke, 0,45 in ³ /stroke
Lubricant	grease NLGI 0, 1, 2
Operating temperature	-23 to +65 °C; -10 to +150 °F
Operating pressure	min. 82 bar, 1 200 psi max. 240 bar, 3 500 psi
Reservoir	0,5 kg; 1.0 lb
Material	acrylic
Connection outlet	1/4 NPTF (F)
Voltage	120 VAC
Transmission ratio	20:1
Dimensions	133 × 184 × 305 mm 5.25 × 7.24 × 12.02 in
Mounting position	vertical
Timer and controller	
On time	10 or 30 sec
Off time	1/2 to 30 min. or 30 min. to 30 h
Alarm contacts	8 amps at 250 VAC
Operating temperature	-23 to +65 °C; -10 to +150 °F



NOTE

Further technical information, technical drawings, accessories, spare parts or product function descriptions available on SKF.com/lubrication.

Pump unit

85444/45



Description

All models are air-operated, positive-displacement pumps delivering a maximum volume by means of a single stroke of the pump. Solenoid air valves and adjustable, solid-state time controls are integrated into the pump body. These pump units are designed to deliver grease to single-line metering devices and include a special high-volume refill fitting. Acrylic reservoirs are available in several sizes. Integrated controls feature LED indicators for "Power On", "Pump On" and "Alarm," along with a membrane-type, "Manual Lube" switch.

Features and benefits

- Reservoir 1,8 kg / 4 lb with spring-loaded follower
- Integrated, adjustable, solid-state time controls with LED indicators
- Integrated solenoid air valve
- High-volume refill fitting
- For use with metering devices of category 5, 6 and 7

Applications

- Food and beverage
- Glass industry

Order information

Order number	Voltage	Transmission ratio	Metering quantity	
	VAC		cm ³ /stroke	in ³ /stroke
85444	120	20:1	7,4	0.45
85445	240	20:1	7,4	0.45



Technical data

Function principle	air operated piston pump (single-stroke)
Outlets	1
Metering quantity	7,4 cm ³ /stroke, 0.45 in ³ /stroke
Lubricant	grease NLGI 0, 1, 2
Operating temperature	-23 to +65 °C; -10 to +150 °F
Operating pressure	min. 82 bar, 1 200 psi max. 240 bar, 3 500 psi
Reservoir	1,8 kg; 4.0 lb
Material	acrylic
Connection outlet	1/4 NPTF (F)
Voltage	120 VAC; 240 VAC
Transmission ratio	20:1
Dimensions	133 x 184 x 527 mm 5.25 x 7.24 x 20.75 in
Mounting position	vertical
Timer and controller	
On time	10 or 30 sec
Off time	1/2 to 30 min. or 30 min. to 30 h
Alarm contacts	8 A at 250 VAC
Operating temperature	-23 to +65 °C; -10 to +150 °F

NOTE

Further technical information, technical drawings, accessories, spare parts or product function descriptions available on SKF.com/lubrication.

Pump unit

85434/35/36



Description

All models are air-operated, positive-displacement pumps delivering a maximum volume by means of a single stroke of the pump. Solenoid air valves and adjustable, solid-state time controls are integrated into the pump body. These pumps are designed to deliver grease to single-line metering devices and include a special high-volume refill fitting. Acrylic reservoirs are available in several sizes. Integrated controls feature LED indicators for "Power On", "Pump On" and "Alarm," along with a membrane-type, "Manual Lube" switch.

Features and benefits

- Integrated, adjustable, solid-state time controls with LED indicators
- Integrated solenoid air valves
- High-volume refill fitting
- For use with metering devices of category 5, 6 and 7

Applications

- Food and beverage
- Glass industry
- Machine tools

Technical data

Function principle	air operated piston pump (single-stroke)
Outlets	1
Metering quantity	depending on model: 18,7 or 35,2 cm ³ /stroke 1.14 or 2.15 in ³ /stroke
Lubricant	grease NLGI 0, 1, 2
Operating temperature	-23 to +65 °C; -10 to +150 °F
Operating pressure	min. 82 bar, 1 200 psi max. 240 bar, 3 500 psi
Reservoir	2,0 kg; 4,5 lb
Material	acrylic
Connection outlet	1/4 NPTF (F)
Voltage	120 VAC; 240 VAC
Transmission ratio	31:1; 25:1
Dimensions	627 × 166 × 460 mm 24.70 × 6.52 × 18.11 in
Mounting position	vertical
Timer and controller	
On time	10 or 30 sec
Off time	1/2 to 30 min. or 30 min. to 30 h
Alarm contacts	8 A at 250 VAC
Operating temperature	-23 to +65 °C; -10 to +150 °F

Order information

Order number	Voltage	Transmission ratio	Metering quantity	
	VAC		cm ³ /stroke	in ³ /stroke
85434	120	31:1	18,70	1.14
85435	240	31:1	18,70	1.14
85436	120	25:1	35,20	2.15



NOTE

Further technical information, technical drawings, accessories, spare parts or product function descriptions available on SKF.com/lubrication.

Pump unit

82653/55, 83800/34



Description

All models are air-operated, positive-displacement pumps delivering a maximum volume by means of a single stroke of the pump. Solenoid air valves and adjustable, solid-state time controls are integrated into the pump body. These pump units are designed to deliver grease to single-line metering devices and include a special high-volume refill fitting. Translucent, acrylic reservoirs with spring-loaded followers are available in several sizes. Pump uses air for forward and return stroke but dispenses lubricant on forward stroke only. Return stroke releases pressure on the lubricant line through included check/relief valve.

Features and benefits

- Remote system components such as 4/2-way valves, adjustments for air power, and monitoring of pump and system are available separately on request
- High-volume refill fitting
- For use with metering devices of category 5, 6 and 7

Applications

- Oil and gas industry
- Chain lubrication



Order information

Order number	Ratio	Metering quantity		Designation
		cm ³ /stroke	in ³ /stroke	
82653	31:1	22,9	1.4	bare pump
82655	31:1	22,9	1.4	pump with controls
83800	25:1	35,2	2.15	pump with controls
83834	25:1	35,2	2.15	bare pump

Technical data

Function principle	air operated piston pump (single-stroke)
Outlets	1
Metering quantity	22,9 to 35,2 cm ³ /stroke 1.4 to 2.15 in ³ /stroke
Lubricant	grease NLGI 0, 1, 2
Operating temperature	-18 to +65 °C; 0 to +150 °F
Operating pressure	min. 82 bar, 1 200 psi max. 240 bar, 3 500 psi
Reservoir	2,0 kg; 4.5 lb
Material	acrylic
Connection outlet	1/4 NPTF (F)
Transmission ratio	31:1; 25:1
Air inlet	1/4 NPTF (F)
Dimensions	470 × 146 × 533 mm 18.5 × 5.75 × 20.9 in
Mounting position	vertical

Timer (for 82655 and 83800 only)

On time	min. 10 sec max. 1 minute, 24 sec
Cycle time	min. 20 sec max. 24 h
Operating voltage	120 VAC, 60 Hz; 110 VAC, 50 Hz
Operating temperature	-23 to +65 °C; -10 to +150 °F

Air consumption at 6,9 bar, 100 psi, is 0,004 M³/min, 0.15 ft³/min, per stroke

NOTE

Further technical information, technical drawings, accessories, spare parts or product function descriptions available on SKF.com/lubrication.

Pump unit

83167



Description

Model 83167 is an air-operated, positive-displacement pump delivering a maximum volume by means of a single stroke of the pump. Solenoid air valves and adjustable, solid-state time controls are integrated into the pump body. This pump unit is designed to deliver grease to single-line metering devices and includes a special high-volume refill fitting. Acrylic reservoirs are available in several sizes. Model 83167 includes a transparent reservoir, spring-loaded follower, vent valve assembly and filler fitting for refilling the reservoir.

Features and benefits

- 2 1/2 inch air motor
- Vent valve assembly
- Operation by air-powered reciprocating strokes and releases pressure on the lubricant line through included check/relief valve (3-way) on air-powered return stroke
- Remote system components such as 3/2-way valves, adjustments for air power, and monitoring of pump are available separately on request
- Two different filling couplers available
- For use with metering devices of category 5, 6 and 7

Applications

- Cement industry
- Food and beverage



Technical data

Order number	83167
Function principle	air operated reciprocating piston pump
Outlets	1
Metering quantity	197 cm ³ /stroke, 12 in ³ /stroke
Lubricant	grease NLGI 0, 1, 2
Operating temperature	-35 to +104 °C; -30 to +220 °F
Operating pressure	min. 82 bar, 1 200 psi max. 240 bar, 3 500 psi
Transmission ratio	40:1
Reservoir	5,0 kg; 11.0 lb
Material	acrylic, nitrile, neoprene, steel, aluminum, zinc
Connection outlet	3/4 NPTF (F)
Air inlet	1/8 NPTF (F)
Dimensions	413 × 229 × 571,5 mm 16.25 × 9.0 × 22.5 in
Mounting position	vertical

Pump requires 3-way air valve
Air consumption at 6,9 bar, 100 psi, is 0,004 M³/min, 0.15 ft³/min, per stroke



NOTE

Further technical information, technical drawings, accessories, spare parts or product function descriptions available on SKF.com/lubrication.

Pump unit

83599



Description

Model 83599 is an air-operated, positive-displacement pump delivering a maximum volume by means of a single stroke of the pump. Solenoid air valves and adjustable, solid-state time controls are integrated into the pump body. The pump is designed to deliver grease to single-line metering devices and includes a special high-volume refill fitting. Acrylic reservoirs are available in several sizes. Model 83599 is similar to Model 83167 except that it includes a base-mounting kit and metal reservoir with indicator rod for visual check of grease level. The reservoir includes a spring-loaded follower.

Features and benefits

- 2 1/2 inch air motor
- Reservoir with spring-loaded follower and indicator rod for visual check of grease level
- Vent valve assembly
- Base mounting kit
- Operation by air-powered reciprocating strokes and releases pressure on the lubricant line through included check/relief valve (3-way) on air-powered return stroke
- Remote system components such as 3/2-way valves, adjustments for air power, and monitoring of pump are available separately on request
- Two different filling couplers available
- For use with metering devices of category 5, 6 and 7

Applications

- Machine tools
- Industrial machinery



Technical data

Order number	83599
Function principle	air operated, reciprocating piston pump
Outlets	1
Metering quantity	197 cm ³ /stroke, 12 in ³ /stroke
Lubricant	grease NLGI 0, 1, 2
Operating temperature	-34 to +121 °C; -30 to +250 °F
Operating pressure	min. 82 bar, 1 200 psi max. 240 bar, 3 500 psi
Transmission ratio	40:1
Reservoir	5,0 kg; 11.0 lb
Material	acrylic, nitrile, neoprene, steel, aluminum, zinc
Connection outlet	3/4 NPTF (F)
Air inlet	1/4 NPTF (F)
Dimensions	462 × 229 × 697 mm 18.19 × 9.0 × 27.44 in
Mounting position	vertical

Pump requires 3-way air valve
Air consumption at 6,9 bar, 100 psi, is 0,004 M³/min, 0.15 ft³/min, per stroke



NOTE

Further technical information, technical drawings, accessories, spare parts or product function descriptions available on SKF.com/lubrication.

Pump unit

HG 1000, HG 2000



Description

The hydraulic lubricator HG is an lubrication system developed for a cost-efficient automatic lubrication in machines and implements having a hydraulic circuit. With the help of the hydraulic lubricator, centralized automatic lubrication can be adapted to such units as dismantlable hoists, small lift trucks and rear lifts of vehicles.

Features and benefits

- Simple piston pump utilizes self-relieving hydraulic lines
- Provides cost-efficient automatic lubrication
- Suitable for use in vehicles or machines having a safe hydraulic circuit that is not constantly in operation
- Pressure rise and fall operation in the pump is activated by powering-on and powering-off the adapted hydraulic circuit
- Pressure rise and fall operation in the lube line, as well as the amount of lube remaining, can be verified from the pressure gauge of the pump unit
- Optional low-level limit alarm can be indicated by a buzzer or indicator lamp 12 or 24 VDC
- Filling coupler with filter
- For use with metering devices of category 4 and 5

Applications

- Vehicles
- Machines
- Dismountable hoists
- Small lift trucks
- Rear lifts of trucks

Technical data

Function principle	hydraulically operated, piston pump
Outlets	1
Metering quantity:	
HG 1000	max. 1 000 cm ³ /stroke; 61 in ³ /stroke
HG 2000	max. 2 000 cm ³ /stroke; 122 in ³ /stroke
Lubricant	grease NLGI 0, 1
Operating temperature	-25 to +80 °C; -13 to +176 °F
Operating pressure	min. 50 bar, 725 psi max. 150 bar, 2 176 psi
Transmission ratio	1:1
Reservoir	1 and 2 kg; 2.2 and 4.4 lb
Material (reservoir)	steel
Grease outlet connection	R 3/4 in ZN; main hose Ø 8 mm, 0.341 in
Hydraulic inlet connection	R 3/4 in ZN; main hose Ø 8 mm, 0.341 in
Operating voltage	12 or 24 VDC
Dimensions:	
HG 1000	345 × 100 × 100 mm; 13.58 × 3.94 × 3.94 in
HG 2000	520 × 100 × 100 mm; 20.47 × 3.94 × 3.94 in
Mounting position	vertical or horizontal

Order information

Order number	Designation	Weight	
		kg	lb
11390060	HG-1000 Pump	7,2	15.8
11390070	HG-2000 Pump	10,2	22.4



NOTE

Further technical information, technical drawings, accessories, spare parts or product function descriptions available on SKF.com/lubrication.

Pump unit

BPH



Description

The hydraulically operated barrel pump series BPH offers all features needed to run the machine without unplanned interruptions. Constructed of heavy-duty material, the pump works reliable in demanding applications, including excavators, loaders, haul trucks and other heavy machinery in construction and mining environment. Featuring a fully encased pump head, damages during tough operation become less likely. The compact design allows to mount the pump even in applications, where space is limited. While hindering fluids to leak, the three-sealing-package provides the extra step to safe and reliable operation. In addition, it minimizes the risk of contamination of hydraulic oils as well as environmental concerns. Flow rate and reverse pressure can be adjusted to fit the application needs. Built-in sensors monitor oil pressure, temperature and piston movement helping to avoid malfunction prior the event.

Features and benefits

- Innovative sealing concept to avoid hydraulic oil and lubrication grease leakage
- Three possible outlet directions, front, left and right
- Compact and robust design for demanding applications
- Optional monitoring sensors for increased reliability
- For use with metering devices of category 5, 6 and 7

Applications

- Construction machinery
- Mining machinery



Technical data

Order numbers:	
BPH30 pump basic	BPH30-3001AB-VAOM
BPH30 pump with sensors	BPH30-3101AB-VAOM
Function principle	hydraulically operated barrel pump
Outlets	1
Metering quantity	30 cm ³ /stroke; 1.83 in ³ /stroke 360 cm ³ /min; 22 in ³ grease NLGI 0, 1, 2
Lubricant	grease NLGI 0, 1, 2
Operating temperature	-40 to +80 °C; -40 to +176 °F
Operating back pressure	max. 320 bar, 4 642 psi
Transmission ratio	min. 10:1
Required viscosity of the hydraulic oil	13 mm – 380 mm ² /s
Nominal oil pressure	35–120 bar; 508–1 740 psi
Suitable barrels	208 l; 55 gal
Material	steel, FKM (FPM), NBR
Corrosion class	C3
Connection outlet	3/4 NPTF (F) or M27×2
Hydraulic oil inlet	G 3/8
Protection class	IP 65
Dimensions	245 × 155 × 1 260 mm 9.6 × 6.1 × 50 in
Mounting position	upright

Pump requires 3-way air valve
Air consumption at 6,9 bar, 100 psi, is 0,004 M³/min, 0.15 ft³/min, per stroke



NOTE

Further technical information, technical drawings, accessories, spare parts or product function descriptions available on SKF.com/lubrication.

PUB LS/P2 19079 EN, 951-171-060-EN

Pump unit

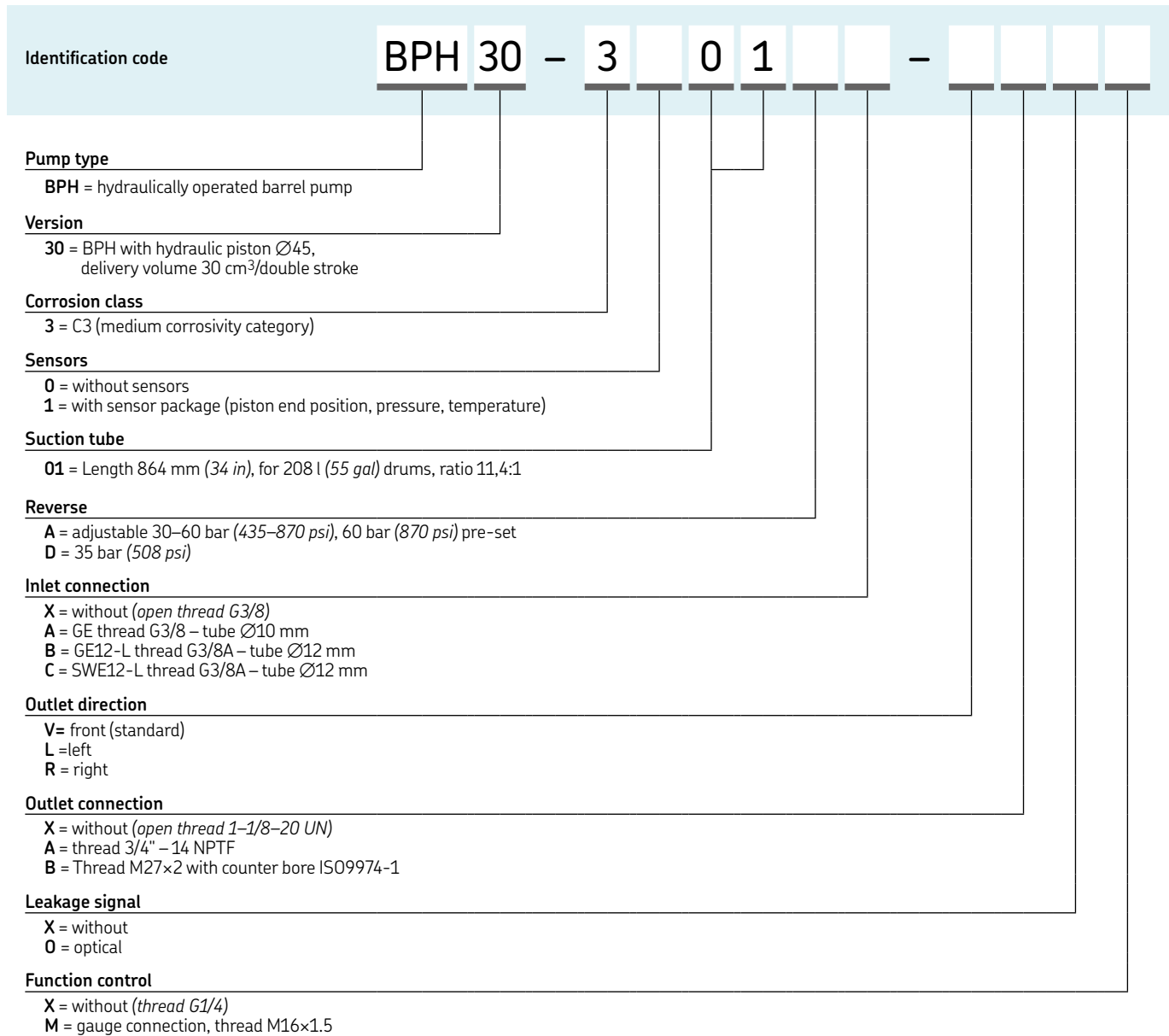
BPH



Pump unit

84944, 84961



Description

Models 84944 and 84961 are pumping systems designed to operate centralized lubrication systems that utilize single-line, parallel grease metering components. The pump is double acting, dispensing lubricant on both the up and down strokes. These units are designed for off-road equipment that utilizes 24 VDC power sources. These units can be used in conjunction with:

Models 244270 (not potted) or 249605 (potted) cycle timers; Model 84944 hydraulically operated pump with 60 lb metal reservoir and vent valve (basic pump); and Model 84961 basic pump (similar to Model 84944 but without reservoir or vent valve). These products include a pump and hydraulic control.

Features and benefits

- Robust
- Pump operates by an electrical signal
- Supplied with metal reservoir with removable cover for easy filling
- Includes a hydraulic operated solenoid vent valve 24 VDC
- Includes a hydraulic pressure reduction valve rated 4 to 55 bar (60 to 800 psi) output
- Bulk filling method
- For use with metering devices of category 5, 6 and 7

Applications

- Construction machinery
- Heavy machines
- Vehicles

Technical data

Order number	84944 84961
Function principle	hydraulically operated, double-acting piston pump
Outlets	1
Metering quantity	180 cm ³ /stroke, 11 in ³ /stroke
Lubricant	grease NLGI 0, 1, 2
Operating temperature	-40 to +57 °C; -40 to +135 °F
Fluid inlet temperature	max. +99 °C; +210 °F
Hydraulic inlet pressure	min. 20 bar, 300 psi max. 205 bar, 3 000 psi
Pressure ratio	16:1
Reservoir	27,0 kg; 60.0 lb
Material	steel, brass, copper, polyurethane, nitrile
Connection outlet	3/4 NPTF (M)
Hydraulic inlet/outlet	1/4 NPTF (M)
Flow rate	at 30 cycles/min: 3,8 l/min, 1.0 gal/min
Operating voltage	24 VDC
Dimensions:	
84944	381 × 495,3 × 889 mm 15 × 19,5 × 35 in
84961	76 × 177,8 × 866,8 mm 3 × 7 × 34.125 in
Mounting position	vertical
Cycle timer	
Voltage	24 VDC
Cycle rate per min	min. 6, max. 60



NOTE

Further technical information, technical drawings, accessories, spare parts or product function descriptions available on SKF.com/lubrication.

Pump unit

84960, 84962



Description

Models 84960 and 84962 are pumps designed to operate centralized lubrication systems that utilize single-line parallel grease metering components. The pumps are double acting, dispensing lubricant on both the up and down strokes. These units are designed for off-road equipment that utilizes 24 VDC power sources. These units can be used in conjunction with Models 244270 (not potted) or 249605 (potted) cycle timers. Included hydraulic solenoids require 24 VDC. Model 84960 is a hydraulic pump for use with U.S. standard 120 lb refinery drums. System components (pump, vent assembly, drum cover and follower plate) must be ordered separately. Model 84962 is a hydraulic pump for custom lubricant container installations. Pump length is sized for U.S. standard 400 lb refinery drum depth.

Features and benefits

- For use with U.S. standard 54 kg (120 lb) refinery drum
- Robust
- Includes a hydraulic pressure reduction valve rated 4 to 55 bar (60 to 800 psi) output
- System components (pump, vent valve assembly, drum cover and follower plate) must be ordered separately
- For use with metering devices of category 5, 6 and 7

Applications

- Mining industry
- Cement industry

Technical data

Order number	84960 84962
Function principle	hydraulically operated, double-acting piston pump
Outlets	1
Metering quantity	180 cm ³ /stroke, 11 in ³ /stroke
Lubricant	grease NLGI 0, 1, 2
Operating temperature	-40 to +57 °C; -40 to +135 °F
Fluid inlet temperature	max. +99 °C; +210 °F
Hydraulic inlet pressure	min. 20 bar, 300 psi max. 205 bar, 3 000 psi
Pressure ratio	16:1
Material	steel, brass, copper, polyurethane, nitrile
Connection outlet	3/4 NPTF (F)
Hydraulic inlet/outlet	1/4 NPTF (M)
Flow rate	at 30 cycles/min: 3,8 l/min, 1.0 gal/min
Operating voltage	24 VDC
Dimensions:	
84960	76 × 177,8 × 1 083 mm 3 × 7 × 42.625 in
84962	76 × 177,8 × 862 mm 3 × 7 × 33.94 in
Mounting position	vertical
Cycle timer	
Voltage	24 VDC
Cycle rate per min	min. 6, max. 60

Pumps require a timed electrical signal to operate. Use 244270 (not potted) or 249605 (potted) cycle timer. Included hydraulic solenoids require 24 VDC. All pumps have a hydraulic pressure-reducing valve rated for 4 to 55 bar, 60 to 800 psi, output. Maximum input is 207 bar (3 000 psi).



NOTE

Further technical information, technical drawings, accessories, spare parts or product function descriptions available on SKF.com/lubrication.

Pump unit

FlowMaster, hydraulic



Description

High-performance FlowMaster hydraulic pumps combine rotary-driven pump motors with reciprocating pump tubes and flexible control features that perform in desert heat and arctic cold. The integrated control manifold adjusts the amount of lubricant and operating pressure. The pump's output is adjustable from 115 to 737 cm³/min (7 to 45 in³/min). FlowMaster pumps are optionally available incl. mechanical overflow prevention system to improve worker and environmental safety by helping to prevent hazards associated with reservoir overfilling.

Features and benefits

- Increases pump life and simplifies pump installation, operation and service
- Pump and reservoir combination models are automatically level-sensor and shut-off system ready
- Premium-choice pump for single-line parallel lubrication systems
- Flexible ranges of use pump only or pump and bucket with follower low- and high-level detection
- Optional overflow prevention system to improve worker safety and minimize environmental concerns caused by overfilling
- For desert heat and cold climates
- For use with metering devices of category 5, 6 and 7

Applications

- Construction machinery
- Mining and mineral processing
- Automotive industry
- Food and beverage
- Paper mills
- Steel mills

Technical data

Function principle	hydraulically operated piston pump
Outlets	1
Metering quantity	adjustable 115 to 737 cm ³ /min 7 to 45 in ³ /min
Lubricant	grease NLGI 0, 1, 2
Hydraulic fluid temperature	max. +93 °C, +200 °F
Operating temperature	-29 to +65 °C, -20 to +150 °F
Operating inlet pressure	20 to 32 bar, 300 to 420 psi
Supply inlet pressure	max. 200 bar, 3 000 psi
Reservoir	16; 27; 41; 54; 180 kg 35; 60; 90; 120; 400 lb
Material	fluoroelastomer, polyurethane, steel, aluminum zinc casting
Connection outlet	1/4 NPTF
Hydraulic inlet flow	max. 28 l/min, 7 gal/min
Solenoid valve coil	24 VDC
Hydraulic inlet port	SAE 4
Tank return port	SAE 6
Transmission ratio with manifold	9:1 at low inlet pressure (20 to 25 bar, 300 to 350 psi) and flow (below 7 lpm, 2 gpm); approaches 11:1 at higher inlet pressure and flow
Dimensions:	
Pump, dip tube length	min. 348 mm; 13.7 in max. 864 mm; 34.02 in
Basic pump	min. 610 × 231 × 291 mm max. 1 126 × 231 × 291 mm min. 24 × 9 × 11.5 in max. 44.3 × 9 × 11.5 in
Pumps with bucket, follower and vent valve	min. 633 × 496 mm max. 1 155 × 496 mm min. 24.9 × 19.5 in max. 45.44 × 19.5 in
Mounting position	vertical

Pump unit

FlowMaster, hydraulic

Order information

Order number	Description	Reservoir capacity		Solenoid manual override	Adjustable flow control	Adjustable pressure control
		kg	lb			
85722	FlowMaster pump and bucket with follower and low-level detection	27	60	–	•	•
85723	FlowMaster pump and reservoir	27	60	–	–	–
85724	FlowMaster pump and reservoir	27	60	–	–	–
85725	FlowMaster pum and bucket with follower and low-level detection	41	90	–	•	•
85726	FlowMaster pum and bucket	41	90	•	–	–
85727	FlowMaster pum and bucket with follower, low- and high-level detection	54	120	–	•	•
85722MS0	FlowMaster pump and bucket with follower and low-level detection, mechanical shut-off device and reservoir	27	60	–	•	•
85725MS0	FlowMaster pump and bucket with follower and low-level detection, mechanical shut-off device and reservoir	41	90	–	•	•
85727MS0	FlowMaster pump and bucket with follower, low- and high-level detection, mechanical shut-off device and reservoir	54	120	–	•	•
85731	FlowMaster pump only	16	35	–	•	•
85732	FlowMaster pump only	27	60	–	•	•
85733	FlowMaster pump only	54/41	120/90	–	•	•
85734	FlowMaster pump only	180	400	–	•	•
85735	FlowMaster pump only	27	60	–	–	–
85741	FlowMaster pump only	27	60	•	–	–
85742	FlowMaster pump only	54/41	120/90	•	–	–

Accessory

Drum cover, follower assembly, vent cvalves etc.

Order number	Description	Reservoir capacity	
		gal	lb
84616	drum cover	18	120
85492	follower assembly	18	120
84990	vent valve assembly	18	120
271606	drum cover	55	400
270982	follower assembly	55	400
271605	vent valve assembly	55	400
84980	vent valve	18, 55	120, 400
237-11204-8	ultrasonic high/low sensor	18, 55	120, 400

Pump unit

MPB



Description

The MPB pump unit is especially designed for automatic lubrication systems. The unique feature in it compared to traditional air-operated barrel pump with mechanical air motor valve is its magnetically operated air motor valve. This will reduce the amount of mechanical components in the air motor and also eliminates the need of lubrication in the air motor. The pump is suitable for use with 18, 50 and 180 kg (40, 120 and 400 lb) lubricant barrels. And when equipped with a suitable adapter MPB pump unit can also be used in lubricant bulk containers.

Features and benefits

- Lubrication-free, electronically controlled air motor enables accurate control of pump output
- Fewer mechanical components extend a service life of the air motor
- Includes self-diagnosing system
- Operates effectively in wide range of temperatures
- IP 65 protection rating

Applications

- Paper industry
- Steel industry
- Heavy industry



Technical data

Function principle	air operated piston pump for barrels
Operating temperature	-10 to +55 °C, 14 to 131 °F
Operating pressure	max. 300 bar, 4 350 psi
Pressure ratio	1:65
Pressure air supply	2 to 4,5 bar, 29 to 65 psi
Air consumption	max. 300 l/min; 80 gal/min
Lubricant	grease up to NLGI 2 oil up to 20–10 000 mm ² /s
Metering quantity per cycle ¹⁾	6,1 cm ³ ; 0,37 in ³
Electrical connections	20–32 V DC
Drum capacity	18, 50 and 180 kg, 40, 120 or 400 lb drum not included
Protection class	IP 65
Dimensions	depending on the model min. 650 × 130 × 130 mm max. 920 × 130 × 130 mm min. 25,6 × 5,11 × 5,11 in max. 36,22 × 5,11 × 5,11 in vertical
Mounting position	vertical

¹⁾ generally approx. 50 cycles/min are assumed



NOTE

Further technical information, technical drawings, accessories, spare parts or product function descriptions available on SKF.com/lubrication:

PUB LS/P8 17178 EN

Pump unit

MPB

Order information

Order number	Designation	Suitable barrel size	
		kg	lb
12381702	SKF-MPB-PUMP-1/8	18	40
12381701	SKF-MPB-PUMP-1/4	50	120
12381700	SKF-MPB-PUMP-1/1	180	400

Accessories

Air regulator unit



Air regulator unit

Order number	Designation
12382666	MAX-V2-SET-MPB

Lid sets



Lid sets

Order number	Designation
ECO version - dynamic pump position on barrel (acc. to filling level)	
12381381	MAXV2-LIDSET-1/1-ECO-MPB
12381382	MAXV2-LIDSET-1/4-ECO-MPB
12381383	MAXV2-LIDSET-1/8-ECO-MPB
STA version - static pump position on barrel	
12381384	MAXV2-LIDSET-1/1-STA-MPB
12381385	MAXV2-LIDSET-1/4-STA-MPB
12381386	MAXV2-LIDSET-1/8-STA-MPB

Pump unit

84050, 85460



Description

Models 84050 and 85460 are air-operated, double-acting pumps for high-volume displacement. Both pumps are supplied with a 27 kg (60 lb) capacity metal reservoir with removable cover for easy filling. It includes an air-operated vent valve and air and lubricant connecting hoses. Model 85460 features a visual low-level and follower plate assembly.

Features and benefits

- Rugged, 14-gauge steel walls
- Large 1 inch NPT inlet for fast filling, 1 1/4 in overflow outlet
- 2 inch foam follower that virtually eliminates grease bypass
- Vent valve to bucket coupling
- Thick mounting ring that withstands severe vibration
- Bulk filling method
- Remote system components such as 3/2-way valves, adjustments for air power, and monitoring of pump are available separately on request
- For use with metering devices of category 5, 6 and 7

Applications

- Pulp and paper industry
- Construction machinery
- Food and beverage
- Mining

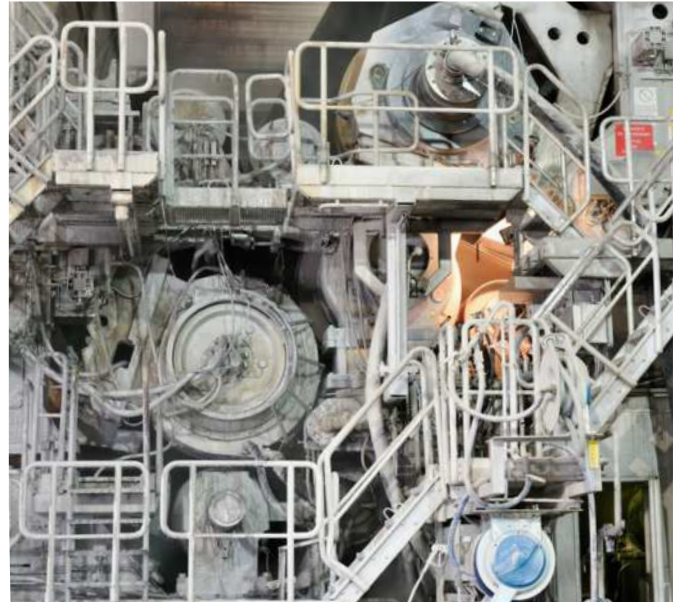

Technical data

Order number	84050 85460
Function principle	air operated, double-acting piston pump
Outlets	1
Metering quantity	492 cm ³ /stroke, 30 in ³ /stroke
Lubricant	grease NLGI 0, 1, 2
Operating temperature	-23 to +60 °C; -10 to +140 °F
Operating pressure	min. 82 bar, 1 200 psi max. 240 bar, 3 500 psi
Transmission ratio	50:1
Reservoir	27,0 kg; 60.0 lb
Material (reservoir)	steel
Connection outlet	3/4 NPTF (F)
Air inlet	3/8 NPTF (F)
Dimensions	806 × 392 × 395 mm 31.75 × 15.44 × 15.56 in
Mounting position	vertical

Pump requires 3-way air valve
Air consumption at 6,9 bar, 100 psi, is 0,004 M³/min, 0.15 ft³/min, per stroke
Optional 92597 follower available

 **NOTE**

Further technical information, technical drawings, accessories, spare parts or product function descriptions available on SKF.com/lubrication.

Pump unit

282288



Description

Model 282288 is an air-operated, positive-displacement pump delivering a maximum volume by means of a single stroke of the pump unit. A solenoid air valve is 58

integrated into the pump body. Designed to deliver grease to single-line metering devices, 282288 includes a special high-volume refill fitting, a 2 1/2 in pneumatically driven pump, a vent valve assembly and air and lubricant connecting hoses.

Features and benefits

- Modular structure consists of 2 1/2 in air motor, pump and vent assembly, air and lubricant connecting hoses
- For U. S. standard refinery drums (removable head)
- For clean and safe drum replacement
- Simplified, modular design
- For use with metering devices of category 5, 6 and 7.

Applications

- Agriculture
- Chemical industry
- Steel industry

Technical data

Order number	282288
Function principle	air operated, reciprocating piston pump
Outlets	1
Metering quantity	492 cm ³ /stroke, 30 in ³ /stroke
Lubricant	grease NLGI 0, 1, 2
Operating temperature	-15 to +121 °C; +5 to +250 °F
Operating pressure	min. 82 bar, 1 200 psi max. 240 bar, 3 500 psi
Transmission ratio	50:1
Reservoir	55 kg; 120 lb
Drum size	standard 120 lb. refinery drum
Material	nitrile, steel, polyurethane
Connection outlet	3/4 NPTF (F)
Air inlet	3/8 NPTF (F)
Voltage (controller)	120 V, 60 Hz; 110 V, 50 Hz
Dimensions	381 × 381 × 975 mm 15 × 15 × 38.375 in
Mounting position	vertical

Air consumption at 6,9 bar, 100 psi, is 0,004 M³/min, 0.15 ft³/min, per stroke
83371 follower plate is available as an optional accessory



NOTE

Further technical information, technical drawings, accessories, spare parts or product function descriptions available on SKF.com/lubrication.

Pump unit

FlowMaster, air operated



Description

High-performance FlowMaster hydraulic pumps combine rotary-driven pump motors with reciprocating pump tubes and flexible control features that perform in desert heat and arctic cold. The integrated control manifold adjusts the amount of lubricant and operating pressure. The pump's output is adjustable from 115 to 737 cm³/min (7 to 45 in³/min). FlowMaster pumps are optionally available incl. mechanical overflow prevention system to improve worker and environmental safety by helping to prevent hazards associated with reservoir overfilling.

Features and benefits

- Increases pump life and simplifies pump installation, operation and service
- Pump and reservoir combination models are automatically level-sensor and shut-off system ready
- Premium-choice pump for single-line parallel lubrication systems
- Flexible ranges of use pump only or pump and bucket with follower low- and high-level detection
- Optional overflow prevention system to improve worker safety and minimize environmental concerns caused by overfilling
- For desert heat and cold climates
- For use with metering devices of category 5, 6 and 7

Applications

- Construction machinery
- Mining and mineral processing
- Automotive industry
- Food and beverage
- Paper mills
- Steel mills



Technical data

Function principle	air operated piston pump
Outlets	1
Metering quantity	adjustable 115 to 737 cm ³ /min 7 to 45 in ³ /min
Lubricant	grease NLGI 0, 1, 2
Hydraulic fluid temperature	max. +93 °C, +200 °F
Operating temperature	-29 to +65 °C, -20 to +150 °F
Operating inlet pressure	20 to 32 bar, 300 to 420 psi
Supply inlet pressure	max. 200 bar, 3 000 psi
Reservoir	16; 27; 41; 54; 180 kg 35; 60; 90; 120; 400 lb
Material	fluoroelastomer, polyurethane, steel, aluminum zinc casting
Connection outlet	1/4 NPTF
Hydraulic inlet flow	max. 28 l/min, 7 gal/min
Solenoid valve coil	24 VDC
Hydraulic inlet port	SAE 4
Tank return port	SAE 6
Transmission ratio with manifold	9:1 at low inlet pressure (20 to 25 bar, 300 to 350 psi) and flow (below 7 lpm, 2 gpm); approaches 11:1 at higher inlet pressure and flow
Dimensions:	
Pump, dip tube length	min. 348 mm; 13.7 in max. 864 mm; 34.02 in
Basic pump	min. 610 × 231 × 291 mm max. 1 126 × 231 × 291 mm min. 24 × 9 × 11.5 in max. 44.3 × 9 × 11.5 in
Pumps with bucket, follower and vent valve	min. 633 × 496 mm max. 1 155 × 496 mm min. 24.9 × 19.5 in max. 45.44 × 19.5 in
Mounting position	vertical

Pump unit

FlowMaster, air operated

Order information

Order number	Description	Reservoir capacity		Solenoid manual override	Adjustable flow control	Adjustable pressure control
		kg	lb			
84050	FlowMaster pump and reservoir	27	60	–	–	–
84060	FlowMaster pump and reservoir	41	90	–	–	–
84050MS0	FlowMaster pump, mechanical shut-off device and reservoir	27	60	–	–	–
84060MS0	FlowMaster pump, mechanical shut-off device and reservoir	41	90	–	–	–

Accessory

Drum cover, follower assembly, vent valves etc.

Order number	Description	Reservoir capacity	
		gal	lb
84616	drum cover	18	120
85492	follower assembly	18	120
84990	vent valve assembly	18	120
271606	drum cover	55	400
270982	follower assembly	55	400
271605	vent valve assembly	55	400
84980	vent valve	18, 55	120, 400
237-11204-8	ultrasonic high/low sensor	18, 55	120, 400

Pump unit

P 603S



Description

The simple-to-install, all-in-one design of the P 603S pump includes the programmable controller, a pressure switch/transducer and a vent valve. It is quick and easy to change out a metering device as the main line or nearby metering devices do not have to be removed. The exchange can be performed between lubrication cycles so that there is no wasted lubricant or excessive costly downtime. An additional pressure switch at the end of larger systems can be used for added pressure control to ensure correct lubrication. For rotating operation in wind turbines, the reservoir is equipped with a follower plate and stirring paddle, which also facilitates the use of fast-separating lubricants. For stationary operations, a stirring and fixed paddle is sufficient.

Features and benefits

- Robust design with easy system layout
- Simple maintenance
- Easy system expansion
- SE1/SE2 suction elements for used lubricant
- QSL/SL metering devices suitable for high pressure
- Suitable for fast-separating lubricants
- For use with metering devices of category 5, 6, 7

Applications

- Wind turbines
- Construction machinery
- Mining and mineral processing
- Commercial vehicles



Technical data

Function principle	electrically operated piston pump
Outlets	1
Metering quantity	12 cm ³ /min, 0.73 in ³ /min
Lubricant	grease up to NLGI 2
Operating temperature	-40 to +70 °C, -40 to +158 °F
Operating pressure	max. 300 bar, 4 350 psi
Reservoir	4; 8; 10; 15 or 20 kg 9, 18, 22, 33 or 44 lb
Pumping elements	3 (Ø 7 mm, 0.27 in)
Paddle	18 rpm
Operating voltage	12, 24 VDC, 115/230 VAC
Current draw	max. 2 A
Protection class	IP 6K9K
Connectors	12, 24 VDC: bayonet style AC: bayonet style plus square type
Switching power supply	12, 24 VDC: no AC: yes
Material	cast aluminum alloy, polycarbonate resin
Connection outlet	G1/4
Dimensions	min. 471 × 240 × 235 mm max. 949 × 240 × 235 mm min. 18.54 × 9.44 × 9.25 in max. 37.08 × 9.44 × 9.25 in
Mounting position	vertical (with follower plate; any)



NOTE

Further technical information, technical drawings, accessories, spare parts or product function descriptions available on SKF.com/lubrication.

Pump unit

P 603S

Order information

Order number	Designation	Power	Reservoir capacity		Follower plate	Internal transducer
			V	kg		
645-41064-3	P603S-4XLF-3Z7-AC-2A7.16-S13-SE	115 / 230 AC	4	9	•	•
645-41062-3	P603S-8XLF-3Z7-AC-2A7.16-S13-SE	115 / 230 AC	8	18	•	•
645-41110-2	P603S-8XLBO-3Z7-AC-3A7.16-S12-SE	115 / 230 AC	8	18	–	•
645-41062-4	P603S-8XLBO-3Z7-AC-3A7.16-S19-SE	115 / 230 AC	8	18	–	•
645-41119-2	P603S-10XLF-3Z7-AC-2A1.01-S13-SE	115 / 230 AC	10	22	•	•
645-41073-5	P603S-15XLF-3Z7-AC-2A7.16-S13-SE	115 / 230 AC	15	33	•	•
645-41064-8	P603S-4XLF1-3Z7-12-1A7.16-S01-SE	12 DC	4	9	• (bayonet)	•
645-41175-5	P603S-4XNBO-3Z7-12-1A7.16-S22-SE	12 DC	4	9	–	•
645-41064-7	P603S-4XNBO-3Z7-12-2A7.16-S01-SE	12 DC	4	9	–	•
645-41110-3	P603S-8XLF1-3Z7-12-1A7.16-S01-SE	12 DC	8	18	• (bayonet)	•
645-41064-4	P603S-4XLBO-3Z7-24-1A7.16-S17-SE	24 DC	4	9	–	•
645-41064-6	P603S-4XLF-3Z7-24-1A7.16-S13-SE	24 DC	4	9	•	•
645-41064-2	P603S-4XNBO-3Z7-24-1A7.16-S01-SE	24 DC	4	9	–	•
645-41062-9	P603S-8XLF-3Z7-24-1A7.16-S01-SE	24 DC	8	18	•	•
645-41062-8	P603S-8XLBO-3Z7-24-2A7.16-S19-SE	24 DC	8	18	–	•
645-41062-7	P603S-8XLF-3Z7-24-1A7.16-S03-SE	24 DC	8	18	•	•
645-41119-1	P603S-10XLF-3Z7-24-1A7.16-S13-SE	24 DC	10	22	•	•

Accessory

Reservoir kits

Order number	Reservoir capacity		Designation
	kg	lb	
276764	15	33	Converts 4 or 8 kg, 9 or 18 lb, reservoirs without follower to 15 kg, 33 lb reservoir
276765	20	44	Converts 4 or 8 kg, 9 or 18 lb, reservoirs without follower to 20 kg, 44 lb reservoir

Pump unit

Minilube



Description

Minilube is a handy solution for vehicles with few lubrication points, such as mini-excavators, mini wheel loaders, buses and delivery trucks. Installing Minilube is easy and quick, because everything is already integrated: control centre, pressure switch and alarm lights. Additional alarm lights can be installed, for example, in the vehicle's cabin. Pumped grease is distributed accurately through pre-engineered metering device groups.

Features and benefits

- Compact lubrication system for few lubrication points
- Improves worker safety as system lubricates all connected lubrication points regardless of machinery location
- Minimizes lubricant waste to environment by maintaining optimal lubrication level
- Easy and quick installation and commissioning
- For use with metering devices of category 4 and 5

Applications

- Small excavators
- Wheel loaders
- Buses
- Delivery trucks
- Vehicles

Technical data

Function principle	electrically operated piston pump
Outlets	1
Metering quantity	
12 VDC	6,5 cm ³ /min, 0,4 in ³ /min
24 VDC	13 cm ³ /min, 0,8 in ³ /min
Lubricant	grease up to NLGI 1
Operating temperature	-30 to +70 °C, -22 to +158 °F
Operating pressure	max. 250 bar, 3 625 psi
Reservoir	2 kg, 4 lb
Material	acrylic, steel, aluminum, polyurethane, nitrile
Connection outlet	R 1/4 in
Operating voltage	12/24 VDC
Power consumption	150 W, 0,2 HP
Protection class	IP 65
Dimensions	327 × 273 × 184 mm 12,9 × 10,75 × 7,25 in
Mounting position	vertical



NOTE

Further technical information, technical drawings, accessories, spare parts or product function descriptions available on SKF.com/lubrication:

12236 EN



3D

skf-lubrication.partcommunity.com/3d-cad-models

Pump unit

Minilube

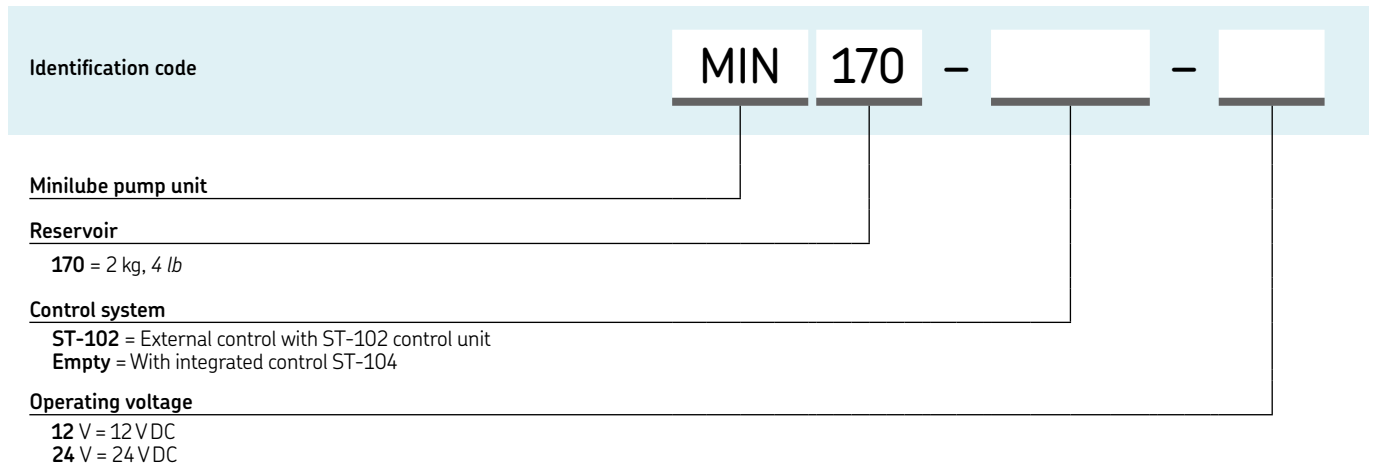

Pump unit

KFG



Description

The KFG pump unit is an electrically driven piston pump. The pump is comprised of four main components: housing with pump elements; reservoir with fill-level monitoring; internal control units; and attachments. The housing integrates the motor, the drive shaft with an eccentric and up to three pump elements for delivering the lubricant. Positively driven pump elements should be used in order to maintain the delivery rate in areas with extremely low temperatures or in applications where an increased influence of dirt is unavoidable.

Features and benefits

- Reliable: due to durable materials, robust components and designs for extreme conditions (with positively driven pump elements)
- Plug-and-play pump design for reduced installation time
- Application-oriented: individual designs through user-friendly product customizer
- Versatile: can be used as a single-line (SKF MonoFlex) and as a progressive pump (SKF ProFlex)
- Safe: through fill-level monitoring, lubrication system monitoring, pressure relief and control unit
- Options: Top filling, several electronic options, Can bus
- For use with metering devices of category 5, 6 and 7

Applications

- Wind turbines
- Construction machinery
- Vehicle aftermarket
- Rotary applications
- Industry



Technical data

Function principle	electrically operated piston pump
Outlets	1–3
Metering quantity	5,0 to 15 cm ³ /min 0.3 to 0.9 in ³ /min
Lubricant	NLGI 000 to 2 with EP additives, compatible with plastics, NBR elastomers, copper and copper alloys
Operating temperature with spring-return pump element	–25 to +70 °C, –13 to +158 °F
Operating temperature with posit. driven pump element	–30 to +70 °C, –22 to +158 °F
Operating pressure	max. 300 bar; 4 351psi
Flow pressure	0,45 to 0,7 bar, 6,5 to 10,2 psi
Reservoir	2; 4; 6; 8; 10; 12; 15; 20 kg 4, 9, 13, 18, 22, 26, 33, 44 lb
Material (reservoir)	polyamide PA 6I, PMMA
Material (pump housing)	aluminum-silicon cast alloy
Connection outlet	M14×1,5 mm
Operating voltage	12 VDC, 24 VDC, 230 VAC (100–273 VAC)
Dimensions	min 229 × 268 × 208mm max 1 170 × 268 × 216 mm min 9.01 × 10.55 × 8.2 in max 46 × 10.55 × 8.5 in
Mounting position	vertical (with follower plate; any)



NOTE

Further technical information, technical drawings, accessories, spare parts or product function descriptions available on SKF.com/lubrication:

1-3030 -EN, 951-170-211



3D

skf-lubrication.partcommunity.com/3d-cad-models

Pump unit

KFG

Position of pump elements

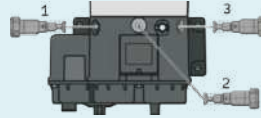

Identification code

K F G +

Product series

Integrated control unit

X = No control unit L = LC502

Reservoir

- 1 = 2 kg, 4 lb (not available for rotary application version)
- 2 = 4 kg, 9 lb (only rotary application version)
- 3 = 6 kg, 13 lb
- 4 = 8 kg, 18 lb (only rotary application version)
- 5 = 10 kg, 22 lb
- 6 = 12 kg, 26 lb (only rotary application version)
- 7 = 15 kg, 33 lb
- 8 = 20 kg, 44 lb (not available for rotary application version)

Range of application

R = Rotary application M = Industry application F = Vehicle application

Filling

- X = Without lubricant (not available for rotary application version)
- A = Grease NLGI-Grade 2 for vehicles (not for capacitive fill-level monitor)
- F = Customized grease

Fill-level monitor

- X = Without fill-level monitor
- 1 = Mechanical level monitor (not available for rotary application version)
- 2 = Mechanical level monitor with signal smoothing (not available for rotary version; only possible with KFGX)
- 3 = Capacitive level monitor (only available for industry version with 2 and 6 kg reservoir)
- 4 = Cylinder switch level monitor (only available for rotary application version)

Pump element or filler socket

Spring-return piston pump

- X = No pump element
- E = 5,0 cm³/min; 0,30 in³/min
- W = Socket for filling cylinder (not available for rotary application version)

Positively driven piston pump

- Y = No pump element
- L = 5,0 cm³/min; 0,30 in³/min
- V = Socket for filling cylinder (not available for rotary application version)

Fitting for main line connection and valves ³⁾

- S = Pressure relief and restriction valve (200 bar/2 900 psi) with SKF Quick Connector for Ø 6 mm tubes
- T = Pressure relief and restriction valve (200 bar/2 900 psi) with SKF Quick Connector for Ø 8 mm tubes
- U = Pressure relief and restriction valve (200 bar/2 900 psi) with solderless pipe union for Ø 10 mm tubes
- V = Pressure relief and restriction valve (200 bar/2 900 psi) with solderless pipe union for Ø 8 mm tubes
- W = Pressure relief and restriction valve (200 bar/2 900 psi) with female thread solderless pipe union for G 1/4 tubes ²⁾

Pump cycle/interval time

- No control unit LC502
- 99 = none EB = 4 min. run time/1 h interval time. Factory setting, additional setting times on request

Voltage key

- 912 = 12 VDC (only available for vehicle application version)
- 924 = 24 VDC
- 486 = 100–273 VAC (not available for vehicle application version)

¹⁾ For technical reasons, the first pump element must always be installed at outlet 1 in SKF MonoFlex systems

²⁾ If the relief valve is configured together with several pump elements, then the lines leading from the pump elements will be joined together ahead of the relief valve

Pump unit

Multilube MLPV/MLPI



Description

Multilube pump units (MLPV for heavy vehicles, MLPI for industrial applications) help to ensure that the lubrication result is optimal, while reducing energy and lubricant consumption. All relevant components (control unit, pump, reservoir, directional valve and pressure monitoring) are integrated into its modular pumping unit. Built-in heating allows it to be operated even under demanding and cold circumstances.

Features and benefits

- Compact, all-in-one structure
- Modular and durable design
- Easy to install and start-up
- Can be used in single-line, dual-line and progressive lubrication systems
- For use in oil and grease lubrication systems
- Two reservoir sizes
- Pumping element equipped with pressure-relief valve
- Filling connection equipped with filling filter
- Visual and electric low-level monitoring in reservoir
- Pumping center is equipped with heating device
- Clear and versatile user interface
- Wide operating temperature range
- For use with metering devices of category 5, 6 and 7

Applications

- Stand-alone machines
- Construction machinery
- Mining applications

Technical data

Function principle	electrically operated piston pump
Outlets	1 (for single-line applications)
Metering quantity	16 cm ³ /min; 0.976 in ³ /min
Lubricant	oil, fluid grease and grease up to NLGI 1
Operating temperature	-30 to +60 °C, -22 to +140 °F
Operating pressure	max. 200 bar, 2 900 psi
Reservoir	4 or 10 kg, 9 or 22 lb
Material	aluminum, polyurethane, nitrile
Connection outlet	G 1/4
Operating voltage	12/24 VDC, 115 VAC, 230 VAC
Power consumption	150 W, 0.2 HP
Protection class	IP 67 (IP 65 with user-interface IF-103)
Dimensions:	
with 4 kg reservoir	539 × 274 × 250 mm
with 9 lb reservoir	21.22 × 10.78 × 9.84 in
with 10 kg reservoir	720 × 274 × 250 mm
with 22 lb reservoir	27.09 × 10.78 × 9.84 in
Mounting position	vertical and horizontal



NOTE

Further technical information, technical drawings, accessories, spare parts or product function descriptions available on SKF.com/lubrication:

6407/2 EN



3D

skf-lubrication.partcommunity.com/3d-cad-models

Pump unit

Multilube MLPV/MLPI

MLPV (vehicle applications)

Order number ¹⁾	Designation	Reservoir capacity		Operating voltage		Control unit
		kg	lb	12 VDC	24 VDC	
11395200	MLPV-4-1-12	4	9	•	–	–
11395210	MLPV-4-1-24	4	9	–	•	–
11395211	MLPV-10-1-24	10	22	–	•	–
11395254	MLPV-4-1-24-IF103-PSE	4	9	–	•	IF103
11395227	MLPV-10-1-12-IF103-PSE	10	22	•	–	IF103

¹⁾ Further MLPV versions available on request.

MLPI (industrial applications)

Order number ¹⁾	Designation	Lubri-cant		Reservoir capacity		Operating voltage			Control unit	Build in pressure sensor
		oil	grease	kg	lb	24 VDC	115 VAC	230 VAC		
12389919	MLPI-4-1-24-IF103-PSE	–	•	4	9	•	–	–	IF103	•
12389942	MLPI-4-1-24-24-PSE	–	•	4	9	•	–	–	–	•
12389937	MLPI-4-1-115-IF103-PSE	–	•	4	9	–	•	–	IF103	•
12389944	MLPI-4-1-115-IF103-EPT	–	•	4	9	–	•	–	IF103	–
12389912	MLPI-4-1-230-IF103-PSE	–	•	4	9	–	–	•	IF103	•
12389925	MLPI-4-1-230-IF103-EPT	–	•	4	9	–	–	•	IF103	–
12389936	MLPI-10-1-115-IF103-PSE	–	•	10	22	–	•	–	IF103	•
12389943	MLPI-10-1-115-IF103-EPT	–	•	10	22	–	•	–	IF103	–
12389916	MLPI-10-1-230-IF103-PSE	–	•	10	22	–	–	•	IF103	•
12389924	MLPI-10-1-230-IF103-EPT	–	•	10	22	–	–	•	IF103	–
12389954	MLPI-10-1-230-24-EPT	–	•	10	22	–	–	•	–	–
12389953	MLPI-10-0S-230-IF103-PSE	•	–	10	22	–	–	•	IF103	•

¹⁾ Further MLPI versions available on request.

Accessories

Control unit



Control unit

Order number	Designation	Description
11500610	ST-102	ST-102 control center to be located in machinery cabin
12380747	e-SMS-C	SMS control and monitoring module

Pump unit

P 653S



Description

The fully integrated P 653S pump unit is an example of the Lincoln brand's commitment to providing innovative, cost-effective solutions through industry-leading advances in technology. This next-generation, lower-cost pump package can be fitted with one of four reservoir sizes and easily adapts to many applications. It also interfaces with telematics technology in today's heavy equipment. A neutral switch allows mobile equipment to remain idling with pump power on, but the timer is deactivated, allowing manual lubrication functionality. All pumps include low-level and system fault alarms. Simply mount the pump, connect the power and supply lines, and the system is ready for operation.

Features and benefits

- Integration of major system components reduces operation costs
- Plug-and-play pump design for reduced installation time
- Neutral switch ensures reduces grease consumption
- For use with metering devices of category 5, 6, 7

Applications

- Renewable energy, construction machinery
- Mining and mineral processing, commercial vehicles



NOTE

Further technical information, technical drawings, accessories, spare parts or product function descriptions available on SKF.com/lubrication.



Technical data

Function principle	electrically operated piston pump
Outlets	1
Metering quantity	24,6 cm ³ /min, 1.5 in ³ /min
Lubricant	grease up to NLGI 2
Operating temperature	VDC: -40 to +70 °C, -40 to +158 °F VAC: 0 to +50 °C, +32 to +122 °F
Operating pressure	pressure switch, fixed: 240 bar, 3 500 psi; pressure transducer, adjustable: 96 to 317 bar, 1 400 to 4 600 psi end of line pressure switch and transducer setting, not adjustable: 172 bar, 2 500 psi
Reservoir	4; 8; 15 or 20 kg, 8.8; 18; 33 or 44 lb
Material (reservoir)	thermoplastic
Connection outlet	G 1/4
Incoming voltage	DC: 19 to 31 VDC AC: 100 to 240 VAC
Current	DC: max. 10 A AC: max. 1,7 A
Frequency	AC: 47 to 63 Hz
Pause time	max. 59 h, 59 min min. 4 min;
Pause time increments	1 hr or 1 min
Pumping time	max. 12 min
Dimensions	min. 240 × 235 × 467 mm max. 240 × 235 × 800 mm min. 9.45 × 9.25 × 18.4 in max. 9.45 × 9.25 × 31 in
Mounting position	vertical
Pump elements	
Piston	∅ 7 mm, 0.28 in
Number connected	3
Protection	IP 6K9K

Pump unit

P 653S

Order information

Order number	Operating voltage		Reservoir capacity		Follower plate	Internal pressure switch	Internal pressure transducer	Internal and end-of-line pressure switch	Internal and end-of-line pressure transducer
	24 VDC	120/230 VAC	kg	lb					
80086	•	–	4	9	–	•	–	–	–
80087	•	–	4	9	–	–	•	–	–
80105	•	–	4	9	–	–	–	•	–
80106	•	–	4	9	–	–	–	–	•
80076	•	–	4	9	•	•	–	–	–
80077	•	–	4	9	•	–	•	–	–
80109	•	–	4	9	•	–	–	•	–
80110	•	–	4	9	•	–	–	–	•
80090	•	–	8	18	–	•	–	–	–
80091	•	–	8	18	–	–	•	–	–
80107	•	–	8	18	–	–	–	•	–
80108	•	–	8	18	–	–	–	–	•
80080	•	–	8	18	•	•	–	–	–
80081	•	–	8	18	•	–	•	–	–
80111	•	–	8	18	•	–	–	•	–
80112	•	–	8	18	•	–	–	–	•
80121	•	–	15	33	•	–	•	–	–
80122	•	–	15	33	–	–	•	–	–
80120	•	–	20	44	–	–	•	–	–
80083	–	•	4	9	–	–	•	–	–
80084	–	•	4	9	–	–	–	•	–
80085	–	•	4	9	–	–	–	–	•
80072	–	•	4	9	•	•	–	–	–
80073	–	•	4	9	•	–	•	–	–
80074	–	•	4	9	•	–	–	•	–
80075	–	•	4	9	•	–	–	–	•
80088	–	•	8	18	–	•	–	–	–
80089	–	•	8	18	–	–	•	–	–
80078	–	•	8	18	•	•	–	–	–
80079	–	•	8	18	•	–	•	–	–
80134	–	•	15	33	–	–	•	–	–
80135	–	•	20	44	•	–	–	–	•

Note: All models are designed for grease and include stirring paddle and low-level detection. Pumps include remote signaling cable, relief valve, electrical connectors and external pressure switch or transducer (as indicated for each model).

Pump unit

E-PUMP



Description

The electrical barrel pumping unit E-PUMP is a versatile barrel pump and it is especially designed for pumping oil or grease lubricants up to NLGI grade 2 into a centralized lubrication system. When equipped with a change-over valve unit, as E-VALV e.g. or a shut-off valve as E-VALVE-S e.g. it can be used either in single-line, dual-line or progressive lubrication systems. A complete pumping center consists of a pumping unit and a lid set. EPUMP-XXX-ECO coding is referring to ECO lid sets (descending pump head with follower plate), which are suitable for greases in NLGI grades 1 and 2 while EPUMP-XXX-STA coding is referring to STA lid sets (pump head always at barrel bottom), which are suitable for oil or greases in NLGI 0, 00 and 000 classes.

Features and benefits

- EPUMP models reflecting typical and often used barrel sizes
- Compact electrically operated pump for applications where no air supply is available
- An internal pressure control and a heating element secure the pump's function in high-pressure conditions and cold climates

Applications

- Heavy industries (paper, steel and other process industries)
- Mining and mineral processing
- Machinery workshops
- Food and beverage
- Cement industry



Technical data

Function principle	electrically operated pump
Outlets	1
Number of pump elements	4
Metering quantity	55 g/min; 0.3880136 oz/min
Operating temperature	-30 to +70 °C, -20 to 160 °F
Operating pressure	max. 240 bar, 3 480 psi
Lubricant	grease up to NLGI 2 oil up to 40–1 000 mm ² /s
Operating voltage	20–32 V DC
Power consumption	150 W
Heater	40W/24V, heater resistor for pump elements in ECO models LED's 5 yellow, 1 green, 1 red
Display	18, 50 and 180 kg, 40, 120 or 400 lb
Drum capacity	drum not included
Pressure sensor	50–240 bar adjustable in 25 bar steps 725.1 to 3480.9 psi in 362.6 psi steps
Protection class	IP 65
Dimensions	depending on the model min. 400 × 400 × 800 mm max. 400 × 400 × 1 300 mm min. 15.75 × 15.75 × 31.49 in max. 15.75 × 15.75 × 51.18 in
Mounting position	vertical



NOTE

Further technical information, technical drawings, accessories, spare parts or product function descriptions available on SKF.com/lubrication

Pump unit

E-PUMP

Order information

Order number	Designation	Lubricant	Control	Suitable barrel size	
				kg	lb
12375000	SKF-EPUMP-1/8-ECO-24-1	Grease up to NLGI 2	integrated control unit for single-line systems	18	40
12375080	SKF-EPUMP-1/4-ECO-24-1	Grease up to NLGI 2	integrated control unit for single-line systems	50	120
12375160	SKF-EPUMP-1/1-ECO-24-1	Grease up to NLGI 2	integrated control unit for single-line systems	180	400
12375200	SKF-EPUMP-1/8-STA-24-1	Oil up to 1 000 mm ² /s	integrated control unit for single-line systems	18	40
12375120	SKF-EPUMP-1/4-STA-24-1	Oil up to 1 000 mm ² /s	integrated control unit for single-line systems	50	120
12375040	SKF-EPUMP-1/1-STA-24-1	Oil up to 1 000 mm ² /s	integrated control unit for single-line systems	180	400

Accessories

Lid sets for grease barrels



Lid sets for grease barrels

Order number	Designation	Lubricant	for barrel size	
			kg	lb
12381280	E-LIDSET-1/8-ECO	Grease	18	40
12381285	E-LIDSET-1/4-ECO	Grease	50	120
12381290	E-LIDSET-1/1-ECO	Grease	180	400

Lid sets for oil

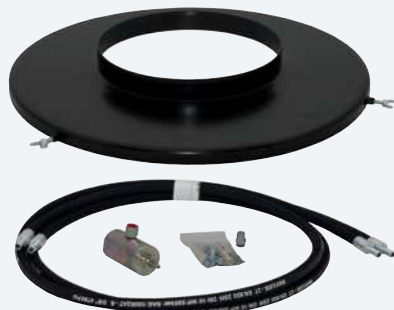

Lid sets for oil barrels

Order number	Designation	Lubricant	for barrel size	
			kg	lb
12381292	E-LIDSET-1/8-STA	Oil	18	40
12381294	E-LIDSET-1/4-STA	Oil	50	120
12381296	E-LIDSET-1/1-STA	Oil	180	400

Pump unit

FK



Description

The FK pump unit is a multi-function piston pump with a versatile, modular structure. The FK pump unit can be used as a single-line, dual-line or progressive pump unit with or without integrated reversing valves. The modular structure of the pump also allows it to be retrofitted from one of the above-mentioned lubrication systems to another system without much effort or expense. The pump, which was designed to handle demanding usage, is available with reservoir sizes of 15 kg (33 lb), 30 kg (66 lb) and 60 kg (132 lb).

Features and benefits

- Versatile, modular system; easy to retrofit to other systems
- High functional reliability due to positively driven pistons
- Fill-level monitoring (using ultrasonic sensor) with two adjustable switching points

Applications

- Automotive industry
- Rotary applications
- Assembly lines
- Printing presses



NOTE

Further technical information, technical drawings, accessories, spare parts or product function descriptions available on SKF.com/lubrication:

1-3033-EN, 951-170-200-EN



3D

skf-lubrication.partcommunity.com/3d-cad-models

Technical data

Function principle	electrically operated piston pump
Outlets	1
Metering quantity	12,3 to 74 cm ³ /min 0.75 to 4.5 in ³ /min
Lubricant	mineral oils or environmentally compatible oils from ISO VG 46 to greases of NLGI Class 2 (consultation required for synthetic oils)
Operating temperature	-25 to +60 °C, -13 to +140 °F
Operating pressure	max. 400 bar, 5 800 psi
Reservoir	15; 30 or 60 kg 33, 66 or 132 lb
Material	steel-sheet housing, steel, aluminum
Operating voltage	230/400 VAC
Pumping elements	1 to 6
Filling method	via filler socket G 1/2
Gear type	screw drive, type 1M
Gear ratio	40:1
Nominal speed	1 500 rpm
Frequency	50 Hz
Nominal output	0,37 kW
Rated current	1,09 A
Protection	IP 55-F
Connection outlet	G 1/2
Dimensions:	
15 kg, 33 lb	max. 470 × 598 × 335 mm max. 18.5 × 23.54 × 13.18 in
30 kg, 66 lb	max. 665 × 598 × 335 mm max. 26.2 × 23.54 × 13.18 in
60 kg, 132 lb	max. 1 035 × 598 × 335 mm max. 40.74 × 23.54 × 13.18 in
Mounting position	vertical

Pump unit

FK

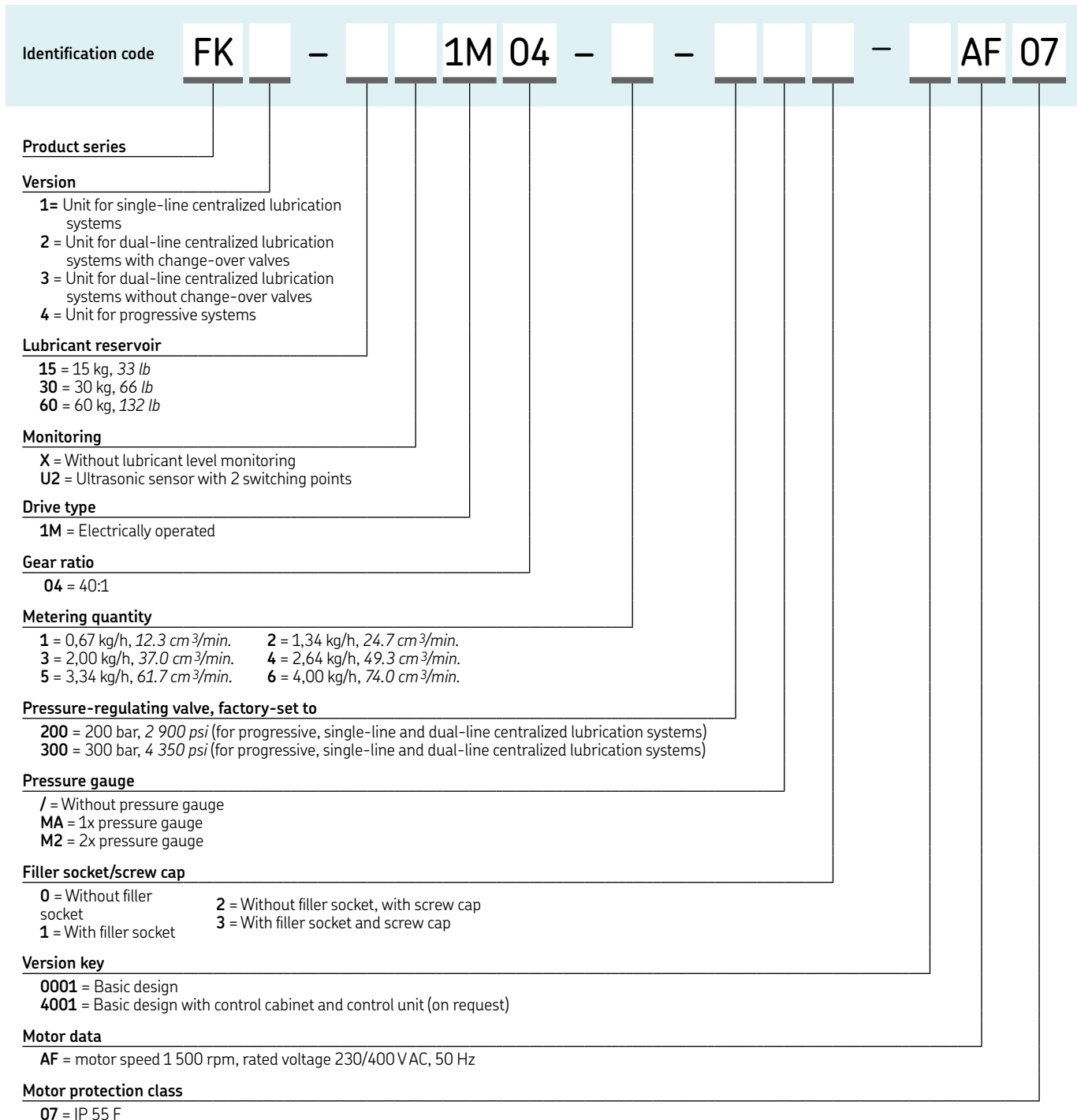

Pump unit

FlowMaster, electric



Description

The high-performance FlowMaster product line is a new generation of pump technology. Compact and versatile, its unique rotary drive and modular gear set let you adjust the speed of the pump's motor to exactly fit your application. FlowMaster pumps can save the cost of air and plug in 12/24 VDC, 120/230-1ph and 230/460-3ph VAC models. The motion of pump created by the electric rotary motor is converted into reciprocating pump motion, providing an efficient lubricant flow. Because of its rotary drive, the motor can be placed directly on the pump. As a result, the pump is so compact it fits almost anywhere. FlowMaster pumps are optionally available incl. mechanical overflow prevention system to improve worker and environmental safety by helping to prevent hazards associated with reservoir overflowing.

Features and benefits

- Advanced technology: brushless DC motor
- Optional overflow prevention system to improve worker safety and minimize environmental concerns caused by overflowing
- Temperature and overload protection: durable and long-lasting product that reduces machinery downtime for maintenance; less repair costs
- Totally sealed: withstands washdowns
- For use with metering devices of category 5, 6 and 7

Applications

- Mining and mineral processing
- Construction machinery
- Food and beverage
- Paper mills
- Steel mills

Technical data

Function principle	electrically operated piston pump
Outlets	1
Metering quantity	max. 103 cm ³ /min max. 6.3 in ³ /min
Lubricant	grease NLGI Grade 0, 1, 2
Operating temperature	-40 to +65 °C; -40 to +150 °F
Operating pressure:	
12 VDC	max. 251 bar; 3 500 psi
24 VDC	max. 345 bar; 5 000 psi
120 to 460 VAC	max. 345 bar; 5 000 psi
Operating voltage	12/24 VDC; 120 to 460 VAC
Reservoir	40, 55, 180 kg; 90, 120, 400 lb
Material	fluoroelastomer, polyurethane, steel, aluminum zinc casting
Connection outlet	1/4 NPTF
Gear ratio	17.8:1; 19:1; 34:1
Nominal power	5 to 50 and 9,5 to 100 rpm
Electric current:	
12/24 VDC	1 to 7.5 A
120 VAC	1 to 4.6 A
230-460 VAC	0,5 to 2,4 A
Dimensions:	
16, 25, 28, 35, 40 kg	360 × 350 × 170 mm
35, 55, 60, 78, 90 lb	14.17 × 13.78 × 6.7 in
55 kg	408 × 223 × 946 mm
120 lb	16.07 × 8.78 × 37.24 in
180 kg	408 × 223 × 1 111 mm
400 lb	16.07 × 8.78 × 43.24 in
Mounting position	vertical



NOTE

Further technical information, technical drawings, accessories, spare parts or product function descriptions available on SKF.com/lubrication

Pump unit

FlowMaster, electric

Order information

Order number	Designation	Power	Reservoir capacity		Ratio	Metering quantity				Operating pressure max.		Speed rpm
			kg	lb		min.	max.	min.	max.	bar	psi	
						cm ³ /min	in ³ /min	cm ³ /min	in ³ /min			
85479	pump, follower, bucket cover, hardware	24 VDC	28	60	19:01	11,5	0,7	103	6.3	170	2 500	9,5–100
85728	pump and reservoir	24 VDC	28	60	19:1	11,5	0,7	103	6.3	345	5 000	9,5–100
85729	pump and reservoir	24 VDC	90	41	19:1	11,5	0,7	103	6.3	345	5 000	9,5–100
85730	pump and reservoir	24 VDC	120	55	19:1	11,5	0,7	103	6.3	345	5 000	9,5–100
85728MSO	pump, reservoir and mechanical shut-off device	24 VDC	28	60	19:1	11,5	0,7	103	6.3	345	5 000	9,5–100
85729MSO	pump, reservoir and mechanical shut-off device	24 VDC	90	41	19:1	11,5	0,7	103	6.3	345	5 000	9,5–100
85730MSO	pump, reservoir and mechanical shut-off device	24 VDC	120	55	19:1	11,5	0,7	103	6.3	345	5 000	9,5–100
85736	pump	24 VDC	16	35	19:1	11,5	0,7	103	6.3	345	5 000	9,5–100
85737	pump	24 VDC	28	60	19:1	11,5	0,7	103	6.3	345	5 000	9,5–100
85738	pump	24 VDC	55/40	120/90	19:1	11,5	0,7	103	6.3	345	5 000	9,5–100
85739	pump	24 VDC	180	400	19:1	11,5	0,7	103	6.3	345	5 000	9,5–100
85740	pump	24 VDC	25	55	19:1	11,5	0,7	103	6.3	345	5 000	9,5–100
85743	pump	115 to 230 VAC	55/40	120/90	19:1	11,5	0,7	103	6.3	345	5 000	95
85744	pump	115 to 230 VAC	180	400	19:1	11,5	0,7	103	6.3	345	5 000	95
85745	pump	220 to 420 VAC, 50 Hz, 3 ph	55/40	120/90	19:1	11,5	0,7	103	6.3	345	5 000	9,5–100
85746	pump	220 to 420 VAC, 50 Hz, 3 ph	180	400	19:1	11,5	0,7	103	6.3	345	5 000	9,5–100
85747	pump	24 VDC	16	35	17.8:1	11,5	0,7	103	6.3	170	5 000	9,5–100
85748	pump	24 VDC	16	35	34:1	6,55	0,4	57,4	3.5	345	5 000	5–50
85749	pump	24 VDC	55/40	120/90	34:1	6,55	0,4	57,4	3.5	345	5 000	5–50
85750	pump	24 VDC	16	35	7:1	11,5	0,7	103	6.3	345	5 000	9,5–100
85751	pump	24 VDC	16	35	7:1	11,5	0,7	103	6.3	345	5 000	9,5–100
85752	pump	12 VDC	16	35	19:1	11,5	0,7	103	6.3	170	2 500	9,5–100
85753	pump	12 VDC	16	35	19:1	11,5	0,7	103	6.3	170	2 500	9,5–100
85754	pump	12 VDC	28	60	19:1	11,5	0,7	103	6.3	345	5 000	9,5–100

Accessory

Drum cover, follower and valves assembly

Order number	Description	Reservoir capacity	
		gal	lb
85474	drum cover	18	120
85492	follower assembly		
85664	vent valve assembly (24 VDC)		
272180	strainer		
85475	drum cover	55	400
270982	follower assembly		
85665	vent valve assembly		

Vent valves

Order number	Description
274899	24 VDC vent valve, IP 67 explosion-proof rating
276325	24 VDC vent valve, IP 65 rating
276903	24 VDC vent valve, IP 65 rating
276919	hardware kit for 276903
525-32083-1	24 VDC vent valve, IP 54 rating



Overview of oil and fluid grease metering devices

Single-line metering devices													
Product	Cate- gory ¹⁾	Lubricant		Metering quantity		Operating pressure		Relief pressure max.		Adjustable metering quantity	Function type	Page	
		oil	fluid grease	cm ³ /stroke	in ³ /stroke	bar	psi	bar	psi				
341	2)	1	•	–	0,01-0,16	0.0006-0.0097	6-80	87-1 160	1 ³⁾	43.5	–	prelubrication	94
340	1		•	–	0,01-0,16	0.0006-0.0097	6-80	87-1 160	1 ³⁾	43.5	–	prelubrication	96
LS22	2)	1	•	–	0,01-0,16	0.0006-0.0097	12-20	174-290	3	43.5	–	prelubrication	98
LS21	2)	1	•	–	0,025-0,5	0.0015-0.0305	12-80	174-1 160	3	43.5	•	prelubrication	99
361	1		•	–	0,02-0,10	0.0010-0.0060	8-40	116-1 160	1	14.5	–	dynamic pulse type	100
351	2)	1	•	–	0,05-0,60	0.0030-0.0366	6-80	87-1 160	1	14.5	–	prelubrication	104
350	1		•	–	0,05-0,60	0.0030-0.0366	6-80	87-1 160	1	14.5	–	prelubrication	106
370	1		•	–	0,05-1,50	0.0030-0.0915	20-80	290-1 160	1	14.5	–	relubrication	108
391	1		•	–	0,20-1,50	0.0122-0.0915	8-45	116-653	1	14.5	–	prelubrication	110
390	1		•	–	0,20-1,50	0.0122-0.0915	8-80	116-1 160	1	14.5	–	prelubrication	112
321 G, T, W, Modul	2		•	•	0,01-0,10	0.0006-0.0060	12-45	174-653	3	43.5	–	special assembly arrangement	114
321 G4,	2		•	•	0,03-0,10	0.0118-0.0060	12-45	174-653	3	43.5	–	special assembly arrangement	114
361	2		•	•	0,01-0,20	0.0006-0.0122	8-80	116-1 160	3	43.5	–	dynamic pulse type	100
321 G7	2		•	•	0,01-0,30	0.0006-0.0183	12-45	174-653	3	43.5	–	special assembly arrangement	114
AB	2)	2	•	•	0,01-0,60	0.0006-0.0366	18-50	261-725	3	43.5	–	prelubrication	116
341	2		•	•	0,03-0,10	0.0018-0.0061	6-80	87-1 160	3	43.5	–	prelubrication	94
340	2		•	•	0,03-0,10	0.0018-0.0061	6-80	87-1 160	3	43.5	–	prelubrication	96
310	2		•	•	0,03-0,16	0.0018-0.0097	12-38	174-551	3	43.5	–	prelubrication	102
VN	2		–	•	0,05-1,00	0.0030-0.0610	20-80	290-1 160	1	14.5	–	relubrication	118
351	2		•	•	0,10-0,60	0.0061-0.0366	6-80	87-1 160	3	43.5	–	prelubrication	104
350	2		•	•	0,10-0,60	0.0061-0.0366	6-80	87-1 160	3	43.5	–	prelubrication	106
Oi-AI-SR	3		•	•	0,02-0,10	0.0012-0.0061	30-100	435-1 450	5	72.5	–	cartridge arrangement	120
391	3		•	•	0,10-0,30	0.0061-0.0183	8-45	116-653	7	101.5	–	prelubrication	110
390	3		•	•	0,10-0,30	0.0061-0.0183	8-45	116-653	7	101.5	–	prelubrication	112
SL-42	4		•	•	0,016-0,049	0.001-0.0029	52-69	750-1 000	10	150	•	prelubrication	122
SL-43	4		•	•	0,016-0,131	0.001-0.0080	52-69	750-1 000	10	150	•	prelubrication	124
SL-41	4		•	•	0,13-1,31	0.0079-0.0799	52-69	750-1 000	10	150	•	prelubrication	126
SL-44	4		•	•	0,13-1,31	0.0079-0.0799	52-69	750-1 000	10	150	•	prelubrication	128

¹⁾ The category allows a simple assignment of the metering device to a pump of the same category. The category results from the relief pressure, the operating principle and the lubricant suitable for the metering device.
²⁾ Stainless steel or C5M available
³⁾ For the metering quantity version 0,01 cm³ and 0,02 cm³ max. relief pressure is 3 bar

Metering device

341



Description

Developed for installation in manifolds, series 341 single-port, prelubrication metering devices are suitable for use with single-line, centralized lubrication systems for oil and fluid grease. The combination of these metering devices with one- to six-port manifolds provides flexible options for lubrication system design. Manifolds customized for product series 341 are available in aluminum and stainless steel.

Features and benefits

- Suitable with manifolds having one to six ports to match number of lubrication points
- Provides flexible options for systems with remote single lubrication points or multiple-port metering devices with up to six ports
- Select optional push-in or screw-in type metering nipples for feed line connections via order code
- Choose separately manifold models with different thread sizes for main line connection and materials
- Current metering nipples above 0,03 cm³ are exchangeable to yield different output quantities

Applications

- Machine tools
- Printing machines
- Packaging industry
- Textile industry



Technical data

Function principle	Metering device
Outlets	1
Metering quantity	oil: 0,01 to 0,16 cm ³ 0,0006 to 0,0097 in ³ fluid grease: 0,03 to 0,10 cm ³ 0,0018 to 0,0061 in ³
Lubricant	mineral and synthetic oil, 20 to 2 000 mm ² /s, 0,031 to 3,100 in ² /s fluid grease of NLGI 000, 00
Operating temperature	0 to +80 °C; +32 to 176 °F
Operating pressure	min. 6 bar, 87 psi max. 80 bar, 1 160 psi
Relief pressure ¹⁾	max. 3 bar, 43,5 psi
Materials	steel (galvanized, Cr6-free), stainless steel, nickel-plated brass, brass, copper, FKM (FPM)/ NBR
Connection main line	pipe Ø 6 to 10 mm, solderless pipe connection for threads
Connection outlet	G 1/8; G 1/4; M10 × 1 or M14 × 1,5 pipe Ø 2,5 mm and Ø 4 mm; metering nipple (VS) with SKF Quick Connector, metering nipple (00) for solderless pipe connection
Dimensions	min. 43,5 × 12 mm; 1,713 × 0,472 in max. 53 × 12 mm; 2,086 × 0,472 in
Mounting position	any

¹⁾ For oil metering quantity version 0,01 cm³ and 0,02 cm³ max. relief pressure is 3 bar



NOTE

Further technical information, technical drawings, accessories, spare parts or product function descriptions available on SKF.com/lubrication:

1-5001-EN



3D

skf-lubrication.partcommunity.com/3d-cad-models

Identification code: 3 4 1 - - - 0 0 0 0 - 0 0

Product series: 3 4 1

Number of metering points (1): 0 0 0 0

Design and metering quantity

Design code	2	4	8	5	9	1	7	6
Lubricant	Oil	Oil	Oil	Fluid grease	Fluid grease	Oil	Fluid grease	Oil
Ø Outlet [mm]	2,5	4	4	4	4	4	4	4
Distributor body	Steel	Steel	Steel	Steel	Steel	Steel	Steel	Steel (1.4305)
Metering nipple	Brass	Brass	Brass	Brass (n.p.)	Brass (n.p.)	Brass	Brass (n.p.)	Steel (1.4305)
Elastomer	NBR	NBR	KFM (FPM)	NBR	FKM (FPM)	NBR	NBR	FKM (FPM)
Threaded seal	FW ²⁾	FW ²⁾	FW ²⁾	FW ²⁾	Flat	O-ring ³⁾	O-ring ³⁾	O-ring ³⁾
Connection outlet	00	VS 00	VS 00	VS 00	00	VS 00	VS 00	00
Metering quantity code	1	1	1	1	1	-	-	1
0,01 cm ³ 1)	1	1	1	1	1	-	-	1
0,02 cm ³ 1)	-	-	6	-	6	-	-	-
0,03 cm ³	2	2	2	2	2	2	2	2
0,06 cm ³	3	3	3	3	3	3	3	3
0,10 cm ³	4	4	4	4	4	4	4	4
0,16 cm ³	5	5	5	5	5	-	-	5

1) Subsequent modification of the metering quantity is not technically possible.
 2) FW=Flat washer must be ordered separately. Order number: **DIN7603-A8x11.5-CU**
 3) O-ring is part of the shipment

Accessory

Manifold



Description

For 341 metering devices, VL-manifolds are utilized for one to six screw-in points with thread M8x1 mm for O-ring or flat (copper) washer sealing. Normal-profile manifolds are available in aluminum and stainless steel, while narrow-profile manifolds are offered in aluminum only.

Identification code: V L - - - - -

Product series: V L

Number of ports: 01 = 1 screw-in point, 02 = 2 screw-in points, 03 = 3 screw-in points, 04 = 4 screw-in points, 05 = 5 screw-in points, 06 = 6 screw-in points (other numbers of ports available on request)

Design of metering device pipe thread: A = Normal profile, M8x1 with counterbore for O-ring, D = Small profile, M8x1 without counterbore

Material: A = Aluminum, E = Stainless steel (1.4305) (can only be selected for normal profile)

Design of main line connection: G1 = G1/8 per DIN 3852-2, Form X, small, G2 = G1/4 per DIN 3852-2, Form X, small, M3 = M10x1 with counterbore for solderless pipe connection per DIN 3862, M4 = M14x1,5 with counterbore for solderless pipe connection per DIN 3862 (can only be selected for normal profile)

Metering device

340



Description

Offered in two-, three- and five-port models, series 340 metering devices were developed for use with single-line, centralized lubrication systems for oil and fluid grease. These metering devices are designed for installation directly on the machine/system requiring lubrication. Series 340 metering devices can be ordered with fittings for the main line connection by selecting the appropriate order code.

Features and benefits

- Designed for installation directly on the machine/system requiring lubrication
- Select optional push-in or screw-in type metering nipples for feed line connections
- Choose optional push-in or screw-in type main line fittings
- Metering nipples above 0,03 cm³ are exchangeable to yield different output quantities

Applications

- Machine tools
- Printing machines
- Packaging industry
- Textile industry

Technical data

Function principle	metering device
Outlets	2, 3 or 5
Metering quantity	oil: 0,01 to 0,16 cm ³ 0.0006 to 0.0097 in ³ grease: 0,03 to 0,10 cm ³ 0.0018 to 0.0061 in ³
Lubricant	mineral and synthetic oil, 20 to 2 000 mm ² /s and fluid grease NLGI 000, 00
Operating temperature	0 to +80 °C; +32 to +176 °F
Operating pressure	min. 6 bar, 87 psi; max. 80 bar, 1 160 psi
Relief pressure ¹⁾	max. 3 bar, 43.5 psi
Materials	zinc die-cast, brass (oil), nickel-plated brass (fluid grease), copper, steel, FKM (FPM)/NBR
Connection main line	different fittings for pipe Ø 6 to 10 mm or closure plugs for thread M10×1
Connection outlet	pipe Ø2,5 and Ø 4 mm metering nipple (VS) with SKF quick connector, metering nipple (00) for solderless pipe connection
Dimensions	min. 48 × 53 × 15 mm max. 99 × 58 × 15 mm min. 1.889 × 2.086 × 0.590 in max. 3.897 × 2.283 × 0.590 in
Mounting position	any

¹⁾ For oil metering quantity version 0,01 cm³ and 0,02 cm³ max. relief pressure is 3 bar

NOTE

Further technical information, technical drawings, accessories, spare parts or product function descriptions available on SKF.com/lubrication:

1-5001-EN



3D

skf-lubrication.partcommunity.com/3d-cad-models

Metering device

340

Identification code

3 4 - - - - -

Product series

Number of metering points (2, 3, 5)

Design and metering quantity

Design code	2	4	8	5
Lubricant	Oil	Oil	Oil	Fluid grease
Ø Outlet [mm]	2,5	4	4	4
Metering nipple	Brass	Brass	Brass	Brass (n.p.)
Elastomer	NBR	NBR	FKM (FPM)	NBR
Connection outlet	00	VS 00	VS 00	VS 00
Metering quantity code				
0,01 cm ³ 1)	1	1	1	-
0,02 cm ³ 1)	-	-	6	-
0,03 cm ³	2	2	2	2
0,06 cm ³	3	3	3	3
0,10 cm ³	4	4	4	4
0,16 cm ³	5	5	5	-
closed 2)	V	V	V	V

Fittings for main line connection

Designation	Ø main line [mm]	Code
Straight adapter	6	B
DIN 3862 with flat washer 1)	8	C
	10	D
Banjo fitting DIN 3862 with flat washer, lockable 1) 2)	6	F
Screw plug with flat washer	-	H
Straight adapter with EO-2 functional nut	6	M
	8	N
	10	P
Straight adapter with SKF Quick Connector	6	T
	8	U
Banjo fitting with SKF Quick Connectors, not lockable	6	V
Vent plug with profile sealing ring	-	Y
Without fitting; for solderless pipe connection 1)	6	Z

1) Subsequent modification of the metering quantity is not technically possible.
2) V = Metering quantity of 0,03 cm³, closed

1) Solderless pipe connection according to DIN 3862 (operating pressure max. 45 bar)
2) Banjo bolt only inserted in delivery condition, not tightened

Accessory

Exchangeable metering nipples



Order numbers for solderless pipe connection metering nipples

Outlet Ø	Elastomer	Lubricant	Order numbers sorted by metering quantity			
mm	in		0,03 cm ³ 0.00183 in ³	0,06 cm ³ 0.00366 in ³	0,10 cm ³ 0.0061 in ³	0,16 cm ³ 0.0097 in ³
2,5	0.10	NBR oil	995-994-003	995-994-006	995-994-010	995-994-016
4	0.16	NBR oil	995-994-103	995-994-106	995-994-110	995-994-116
4	0.16	NBR oil	341-453-K-S8	341-456-K-S8	341-460-K-S8	341-466-K-S8
4	0.16	NBR fluid grease	341-853-K	341-856-K	341-860-K	-



Order numbers for SKF Quick Connector metering nipples

Outlet Ø	Elastomer	Lubricant	Order numbers sorted by metering quantity			
mm	in		0,03 cm ³ 0.00183 in ³	0,06 cm ³ 0.00366 in ³	0,10 cm ³ 0.0061 in ³	0,16 cm ³ 0.0097 in ³
4	0.16	NBR oil	995-994-103-VS	995-994-106-VS	995-994-110-VS	995-994-116-VS
4	0.16	FKM oil	341-453-S8-VS	341-456-S8-VS	341-460-S8-VS	341-466-S8-VS
4	0.16	NBR fluid grease	341-853-VS	341-856-VS	341-860-VS	-

Metering device

LS22



Description

Developed for installation in manifolds, LS22 are single-port metering devices for oil and special lubricants. When used in combination with one- to five-port manifolds, these prelubrication metering devices provide flexible options for lubrication system design. Connections with or without (M8x1) a quick-release connector are offered for feed lines and connections with a quick-release connector are available for main line tubes.

Features and benefits

- For use with manifolds having one to five ports to match number of lubrication points
- Compatible with \varnothing 4 mm for feed lines and \varnothing 8 for main lines
- Suitable for push-in or screw-in type fittings for dosers and push-in type fittings for manifolds
- Robust, reliable
- Suitable for up to 200 lubrication points

Applications

- Conveyor chain surfaces and guides
- Food and beverage
- Packaging

Technical data

Function principle	metering device
Outlets	1
Metering quantity	0,010 to 0,160 cm ³ 0.0006 to 0.0097 in ³
Lubricant	mineral and synthetic oil, 5 to 2 500 mm ² /s; 0.007 to 3.875 in ² /s or LDTS1 (dry film lubricant with synthetic oil and PTFE additions)
Operating temperature	0 to +50 °C; +32 to +122 °F
Operating pressure	min. 12 bar; 174 psi max. 20 bar; 290 psi
Relief pressure	max. 3 bar; 43.5 psi
Materials	stainless steel 303, FKM (FPM), high phosphorus FDA chem. nickel-plated brass
Connection main line	push-in connectors for pipe \varnothing 8 mm and thread G 1/4
Connection outlet	with or without push-in connectors for pipe \varnothing 4 mm and thread M10x1
Dimensions	min. 89 × 68,5 × 20 mm max. 179 × 84 × 20 mm min. 3.5 × 2.67 × 0.8 in max. 7.0 × 3.3 × 0.8 in
Mounting position	any

Order information

Order number	Outlet(s)
LS2210	1
LS2220	2
LS2230	3
LS2240	4
LS2250	5



NOTE

Further technical information, technical drawings, accessories, spare parts or product function descriptions available on SKF.com/lubrication:

15848 EN



3D

skf-lubrication.partcommunity.com/3d-cad-models

Metering device

LS21



Description

Developed for installation in manifolds, LS21 are single-port metering devices for oil and special lubricants. When used in combination with one- to five-port manifolds, these adjustable prelubrication metering devices provide flexible options for lubrication system design. Connections with or without (M8x1) a quick-release connector are offered for feed lines, and connections with a quick-release connector are available for main line tubes.

Features and benefits

- For use with manifolds having one to five ports to match number of lubrication points
- Compatible with \varnothing 4 mm for feedlines and \varnothing 8 for main lines
- Suitable for push-in type fittings for dosers and manifolds
- Robust, reliable
- Suitable for up to 200 lubrication points

Applications

- Conveyor chain surfaces and guides
- Food and beverage
- Packaging

Technical data

Function principle	Adjustable metering device
Outlets	1
Metering quantity	adjustable 0,025 to 0,5 cm ³ 0.0015 to 0.0305 in ³
Lubricant	mineral and synthetic oil, 5 to 2 500 mm ² /s; 0.007 to 3.875 in ² /s or LDTS1 (dry film lubricant with synthetic oil and PTFE additions)
Operating temperature	0 to +50 °C; +32 to +122 °F
Operating pressure	min. 12 bar; 174 psi max. 20 bar; 290 psi
Relief pressure	max. 3 bar; 43.5 psi
Materials	stainless steel 303, FKM (FPM), high phosphorus FDA chem. nickel-plated brass
Connection main line	push-in connectors for pipe \varnothing 8 mm and thread G 1/4
Connection outlet	with or without push-in connectors for pipe \varnothing 4 mm and thread M10x1
Working frequency	\leq 1 stroke/2 s
Dimensions	min. 89 x 92 x 20 mm max. 179 x 110 x 20 mm min. 3.5 x 3.622 x 0.8 in max. 7.0 x 4.330 x 0.8 in
Mounting position	any

Order information

Order number	Outlet(s)
LS2110	1
LS2120	2
LS2130	3
LS2140	4
LS2150	5



NOTE

Further technical information, technical drawings, accessories, spare parts or product function descriptions available on SKF.com/lubrication:

15848 EN



3D

skf-lubrication.partcommunity.com/3d-cad-models

Metering device

361



Description

Designed for installation in manifolds, series 361 single-port, dynamic metering devices were developed for use with single-line, centralized lubrication systems for oil and fluid grease. When used in combination with one- to six-port manifolds, these metering devices provide flexible options for lubrication system design. Customized manifolds for series 361 metering devices are available in aluminum.

Features and benefits

- For use with manifolds having one to six ports to match number of lubrication points
- Designed for installation directly on the machine/system requiring lubrication
- Select screw-in type distributor with feed line connections via order code
- Choose separately optional manifold models with different thread sizes for main line connection

Applications

- Chain lubrication
- Transport and conveyor belts

Technical data

Function principle	metering device
Outlets	1
Metering quantity	oil and fluid grease: 0,01 to 0,20 cm ³ ; 0.0006 to 0.012 in ³ synthetic oil: 0,02 to 0,10 cm ³ ; 0.001 to 0.006 in ³
Lubricant	mineral and synthetic oil: 10 to 1 000 mm ² /s, 0.015 to 1.55 in ² /s fluid grease of NLGI 000, 00
Operating temperature	0 to +80 °C; +32 to +176 °F
Operating pressure	min. 8 bar, 116 psi max. 80 bar, 1 160 psi
Relief pressure	max. 3 bar; 43.5 psi
Materials	steel (galvanized, Cr6-free), (oil, grease), brass (oil), copper, flat washer (copper), NBR
Connection main line	pipe Ø 6 to 12 mm, 0.236 to 0.472 in; solderless pipe connection for threads G 1/8; G 1/4; M10×1 or M14×1,5 (DIN 3862)
Connection outlet	pipe Ø 4 mm straight compression nut fitting
Dimensions	min. 42 × 14 mm max. 46,5 × 14 mm min. 1.653 × 0.551 in max. 1.830 × 0.551 in
Mounting position	any



NOTE

Further technical information, technical drawings, accessories, spare parts or product function descriptions available on SKF.com/lubrication:

1-5001-EN



3D

skf-lubrication.partcommunity.com/3d-cad-models

Metering device

361

Identification code: 3 6 1 - 0 0 - 0 0 0 0 - 0 0

Product series: 361

Number of metering points (1): 00

Design and metering quantity:

Design code	1	2
Lubricant	Oil, fluid grease	Oil
Ø Outlet [mm]	4	4
Distributor body	Steel, galvanized	Brass
Metering nipple	Steel, galvanized	Brass
Elastomer	NBR	NBR
Connection outlet	00	00
Metering quantity code	1	-
	2	2
	3	3
	4	4
	5	5
	6	-

0,01 cm³
0,02 cm³
0,03 cm³
0,05 cm³
0,10 cm³
0,20 cm³

Flat washer must be ordered separately. Order number: 504-019

Metering devices for oil

Accessory

Manifold



Description

For 361 metering devices, VL-manifolds are utilized for one to six screw-in points with thread M10x1 mm for flat washer sealing. Various main line connections can be selected via order code.

Identification code: V L - [] [] [] [] [] []

Product series: VL

Number of ports: 01 = 1 screw-in point, 02 = 2 screw-in points, 03 = 3 screw-in points, 04 = 4 screw-in points, 05 = 5 screw-in points, 06 = 6 screw-in points (other numbers of ports available on request)

Design of metering device pipe thread: B = Normal profile, M10x1 with counterbore for flat washer or O-ring

Material: A = Aluminum, E = Stainless steel (1.4305) (can only be selected for normal profile)

Design of main line connection: G1 = G1/8 per DIN 3852-2, Form X, small; G2 = G1/4 per DIN 3852-2, Form X, small; M3 = M10x1 with counterbore for solderless pipe connection per DIN 3862; M4 = M14x1,5 with counterbore for solderless pipe connection per DIN 3862 (can only be selected for normal profile)

Metering device

310



Description

As the industry's first non-metallic metering device, SKF's Series 310 has a unique appearance. However, its sleek, contemporary design provides proven SKF reliability for a minimum of 400 000 lubrication cycles. Developed for pre-lubrication applications using oil and fluid grease, this metering device is simple to install utilizing plastic or metallic lines and can be mounted in either an upright or inverted position. It also features easily identifiable dosing elements to meet various lubrication requirements.

Features and benefits

- Suitable for use with plastic tubes or metal pipes
- Color-coded dosing elements to identify lubricant volumes
- Provides precise metering of lubricant
- Simple, flexible machine mounting in any position
- 2-, 3- or 5-port manifolds available
- Suitable for oil and fluid grease

Applications

- Machine tools
- Textile and wood industry
- Printing machines
- Conveyors



Technical data

Function principle	metering device
Outlets	2, 3 or 5
Metering quantity	0,03 to 0,16 cm ³ 0,0018 to 0,0097 in ³
Lubricant	mineral and synthetic oil, 20 to 1 500 mm ² /s fluid grease: NLGI 00 and 000
Operating temperature	+5 to +50 °C; +41 to +122 °F
Operating pressure	min. 12 bar, 174 psi max. 38 bar, 551 psi
Relief pressure	max. 3 bar; 43,5 psi
Materials	high-performance PA66 resin
Connection main line	fittings for Ø 6 mm lines
Connection outlet	fittings for Ø 4 mm lines
Dimensions	min. 68 × 70 × 20,5 mm max. 119 × 70 × 20,5 mm min. 2.67 × 2.75 × 8.07 in max. 4.68 × 2.75 × 8.07 in
Mounting position	any



NOTE

Further technical information, technical drawings, accessories, spare parts or product function descriptions available on SKF.com/lubrication:

17505 EN



3D

skf-lubrication.partcommunity.com/3d-cad-models

Metering device

310

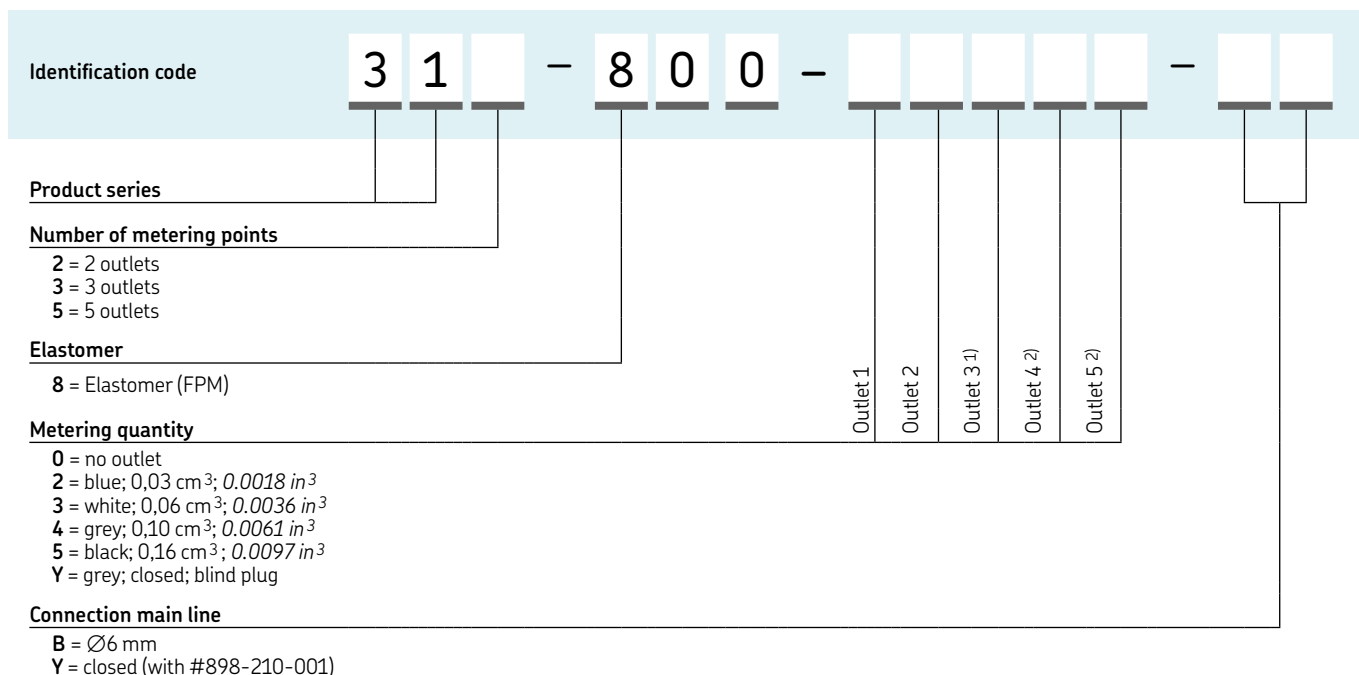

1) Not available for 2-outlet manifold 312 = 0
 2) Not available for 2- and 3-outlet manifold 312 = 0; 313 = 0

Accessory

End-of-line plug



End-of-line plug

Order number	Description
898-210-001	End-of-main-line plug

Description

End-of-line plug suitable to plug main line outlet of 310 metering device to close the lubrication system. The red colour singalizes the end of the lubrication system.

Metering device

351



Description

Designed for installation in manifolds, series 351 single-port, pre-lubrication metering devices were developed for use with single-line, centralized lubrication systems for oil and fluid grease. When used in combination with one- to six-port manifolds, these metering devices provide flexible options for lubrication system design. Customized manifolds for series 351 metering devices are available in aluminum and stainless steel.

Features and benefits

- For use with manifolds having one to six ports to match number of lubrication points
- Provides flexible options for systems with remote single lubrication points or multiple-port metering devices with up to six ports
- Select optional push-in or screw-in type nipples for feed line connections
- Choose separately manifold models with different thread sizes for main line connection and materials
- Current metering nipples are exchangeable to yield different output quantities

Applications

- Machine tools
- Printing machines
- Packaging industry
- Textile industry

Technical data

Function principle	metering device
Outlets	1
Metering quantity	oil: 0,05 to 0,60 cm ³ 0,0030 to 0,0366 in ³ fluid grease: 0,10 to 0,60 cm ³ 0,0061 to 0,0366 in ³
Lubricant	mineral and synthetic oil, 20 to 2 000 mm ² /s and fluid grease NLGI 000, 00
Operating temperature	0 to +80 °C; +32 to +176 °F
Operating pressure	min. 6 bar, 87 psi max. 80 bar, 1 160 psi
Relief pressure	max. 3 bar, 43,5 psi
Materials	aluminum, stainless steel, brass (oil), nickel-plated brass (grease), flat washer (copper, stainless steel), FKM (FPM)/NBR
Connection main line	pipe Ø 6 to 12 mm solderless pipe connection for threads G 1/8; G 1/4; M10 × 1 or M14 × 1,5 (DIN 3862)
Connection outlet	pipe Ø 4 mm metering nipple (VS) with SKF Quick Connector - metering nipple (00) for solderless pipe connection
Dimensions	min. 43,5 × 12 mm; 1,713 × 0,472 in max. 53 × 12 mm; 2,086 × 0,472 in
Mounting position	any

NOTE

Further technical information, technical drawings, accessories, spare parts or product function descriptions available on SKF.com/lubrication:

1-5001-EN



3D

skf-lubrication.partcommunity.com/3d-cad-models

Metering device

351

Identification code 3 5 1 - - - 0 0 0 0 - 0 0

Product series 3 5 1

Number of metering points (1) 0 0 0 0

Design and metering quantity

Design code	0	8	4	1	7	2	3	6
Lubricant	Oil	Oil	Oil	Fluid grease	Fluid grease	Oil	Fluid grease	Oil
Ø Outlet [mm]	4	4	4	4	4	4	4	4
Distributor body	Aluminum	Aluminum	Steel (1.4305)	Aluminum	Aluminum	Aluminum	Aluminum	Steel (1.4305)
Metering nipple	Brass	Brass	Steel (1.4305)	Brass (n.p.)	Brass (n.p.)	Brass	Brass (n.p.)	Steel (1.4305)
Elastomer	NBR	FKM (FPM)	FKM (FPM)	NBR	FKM (FPM)	NBR	NBR	FKM (FPM)
Threaded seal	FW ¹⁾	FW ¹⁾	Steel (1.4305) ²⁾	FW ¹⁾	FW ¹⁾	O-ring ³⁾	O-ring ³⁾	O-ring ³⁾
Connection outlet	VS 00	VS 00	00	VS 00	VS 00	VS 00	VS 00	00
Metering quantity code	0,05 cm ³	3 3	3 3	-	-	-	-	-
	0,10 cm ³	4 4	4 4	4	4	4	4	4
	0,20 cm ³	5 5	5 5	5	5	5	5	5
	0,30 cm ³	-	-	-	-	-	-	-
	0,40 cm ³	6 6	6 6	6	6	6	6	6
	0,60 cm ³	7 7	7 7	7	7	7	7	7

¹⁾ FW=Flat washer must be ordered separately. Order number: 504-019
²⁾ Stainless steel ring must be ordered separately. Order number: 99-1031-7603
³⁾ O-ring is part of the shipment

Accessory

Manifold



Description

For 351 metering devices, VL-manifolds are utilized for one to six screw-in points with thread M10x1 mm for O-ring or flat (copper) washer sealing. Various main line connections can be selected via order code.

Identification code V L - - - - -

Product series V L

Number of ports
 01 = 1 screw-in point 04 = 4 screw-in points
 02 = 2 screw-in points 05 = 5 screw-in points
 03 = 3 screw-in points 06 = 6 screw-in points
 (other numbers of ports available on request)

Design of metering device pipe thread
 B = Normal profile, M10x1 with counterbore for flat washer or O-ring

Material
 A = Aluminum E = Stainless steel (1.4305) (can only be selected for normal profile)

Design of main line connection
 G1 = G1/8 per DIN 3852-2, Form X, small M4 = M14x1,5 with counterbore for solderless pipe connection per DIN 3862 (can only be selected for normal profile)
 G2 = G1/4 per DIN 3852-2, Form X, small
 M3 = M10x1 with counterbore for solderless pipe connection per DIN 3862

Metering device

350

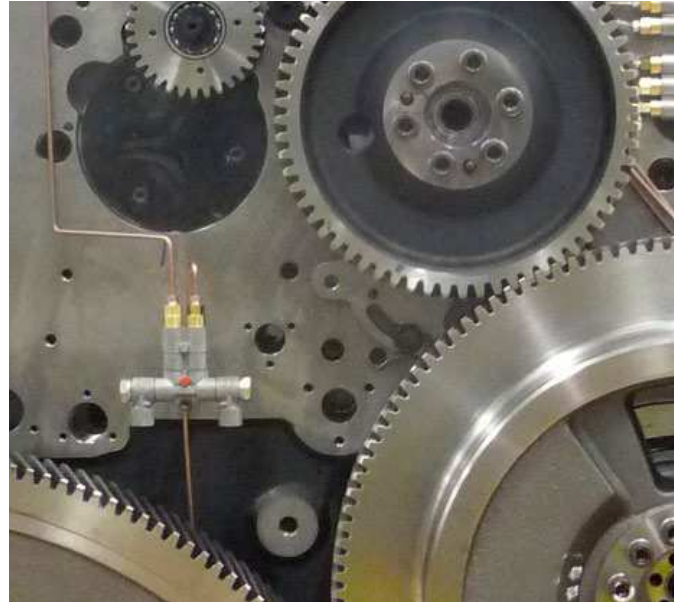

Description

Designed for installation directly on the machine/system requiring lubrication, series 350 single-line, prelubrication metering devices are available in two-, three- and five-port models. These metering devices were developed for use with single-line, centralized lubrication systems for oil and fluid grease. Series 350 metering devices can be ordered with fittings for the main line connection by selecting the appropriate order code.

Features and benefits

- For use with distributor bodies having two, three and five ports to match number of lubrication points
- Designed for installation directly on the machine/system requiring lubrication
- Select push-in or screw-in type metering nipples for feed line connection with metering device bodies
- Choose push-in or screw-in type main line fittings with metering device bodies
- Current metering nipples above 0,03 cm³ are exchangeable to yield different output quantities

Applications

- Machine tools
- Printing machines
- Packaging industry
- Textile industry
- Agriculture

Technical data

Function principle	metering device
Outlets	2, 3 or 5
Metering quantity	oil: 0,05 to 0,60 cm ³ 0,003 to 0,037 in ³ grease: 0,10 to 0,60 cm ³ 0,0061 to 0,037 in ³
Lubricant	mineral and synthetic oil, 20 to 2 000 mm ² /s and fluid grease NLGI 000, 00
Operating temperature	0 to +80 °C; +32 to +176 °F
Operating pressure	min. 6 bar, 87 psi; max. 80 bar, 1 160 psi
Relief pressure	max. 3 bar, 43,5 psi
Materials	zinc die-cast, brass (oil), nickel-plated brass (fluid grease), copper, steel, FKM (FPM)/NBR
Connection main line	different fittings for pipe Ø 6 to 10 mm; 0,236 to 0,393 in or closure plugs for thread M 12×1
Connection outlet	pipe Ø 4 mm metering nipple (VS) with SKF Quick Connector - metering nipple (00) for solderless pipe connection
Dimensions	min. 46 × 83 × 18 mm max. 97 × 86 × 18 mm min. 1.811 × 3.267 × 0.708 in max. 3.818 × 3.385 × 0.708 in
Mounting position	any



NOTE

Further technical information, technical drawings, accessories, spare parts or product function descriptions available on SKF.com/lubrication:

1-5001-EN



3D

skf-lubrication.partcommunity.com/3d-cad-models

Metering device

350

Identification code

3
5

Product series

Number of metering points (2, 3, 5)

Design and metering quantity				
Design code	0	8	1	7
Lubricant	Oil	Oil	Fluid grease	Fluid grease
Ø Outlet [mm]	4	4	4	4
Metering nipple	Brass	Brass	Brass (n.p.)	Brass (n.p.)
Elastomer	NBR	FKM (FPM)	NBR	FKM (FPM)
Connection outlet	VS 00	VS 00	VS 00	VS 00
Metering quantity code	0,05 cm ³	3 3	3 3	- -
	0,10 cm ³	4 4	4 4	4 4
	0,20 cm ³	5 5	5 5	5 5
	0,30 cm ³	- -	- -	6 6
	0,40 cm ³	6 6	6 6	- -
	0,60 cm ³	7 7	7 7	- -
closed*	V V	V V	V V	V V

Fittings for main line connection		
Designation	Main line [mm]	Code
Straight adapter	6	B
DIN 3862 with flat washer ¹⁾	8	C
	10	D
Banjo fitting DIN 3862	6	E
with flat washer, lockable ^{1) 2)}	8	F
Screw plug with flat washer	-	H
	6	M
Straight adapter	8	N
with EO-2 functional nut	10	P
	12	R
Straight adapter	6	S
with SKF Quick Connector	8	T
Banjo fitting with	6	W
SKF Quick Connectors	8	X
Without fitting (M12x1 thread)	-	Z

V = Metering quantity of 0,20 cm³, closed

¹⁾ Solderless pipe connection according to DIN 3862 (operating pressure max. 45 bar)
²⁾ Banjo bolt only inserted in delivery condition, not tightened

Accessory

Exchangeable metering nipples

Order numbers for metering nipples for oil (replaceable)								
Outlet Ø		Material elastomer	Metering nipple	Metering quantity				
mm	in			0,05 cm ³ 0.003 in ³	0,10 cm ³ 0.006 in ³	0,20 cm ³ 0.012 in ³	0,40 cm ³ 0.024 in ³	0,60 cm ³ 0.036 in ³
4	0.16	NBR	00	352-005-K	352-010-K	352-020-K	352-040-K	352-060-K
4	0.16	NBR	VS	352-005-VS	352-010-VS	352-020-VS	352-040-VS	352-060-VS
4	0.16	FKM (FPM)	00	352-005-K-S8	352-010-K-S8	352-020-K-S8	352-040-K-S8	352-060-K-S8
4	0.16	FKM (FPM)	VS	352-005-S8-VS	352-010-S8-VS	352-020-S8-VS	352-040-S8-VS	352-060-S8-VS

Order numbers for metering nipples for fluid grease (replaceable)								
Outlet Ø		Material elastomer	Metering nipple	Metering quantity				
mm	in			0,10 cm ³ 0.006 in ³	0,20 cm ³ 0.012 in ³	0,30 cm ³ 0.018 in ³	0,60 cm ³ 0.036 in ³	
4	0.16	NBR	00	995-993-610	995-993-620	995-993-630	995-993-660	
4	0.16	NBR	VS	995-993-610-VS	995-993-620-VS	995-993-630-VS	-	
4	0.16	FKM (FPM)	00	352-010-K-S82	352-020-K-S82	352-030-K-S82	-	
4	0.16	FKM (FPM)	VS	352-010-S82-VS	352-020-S82-VS	352-030-S82-VS	-	

Metering device

370



Description

Series 370 relubrication metering devices were developed for use with single-line, centralized lubrication systems for oil. Designed for installation directly on the machine/system requiring lubrication, these metering devices are available in two-, three- and five-port models. Series 370 metering devices can be ordered with fittings for the main line connection by selecting the appropriate order code.

Features and benefits

- For use with distributor bodies having two, three and five ports to match number of lubrication points
- Designed for installation directly on the machine/system requiring lubrication
- Choose optional metering nipples and push-in or screw-in type fittings for feed line connections
- Select SKF Quick Connector or screw-in type main line fittings
- Current metering nipples are easily exchangeable to yield different output quantities

Applications

- Machine tools
- Printing machines
- Packaging industry
- Textile industry

Technical data

Function principle	metering device
Outlets	2, 3 or 5
Metering quantity	0,05 to 1,50 cm ³ 0,003 to 0,091 in ³
Lubricant	mineral and synthetic oil 20 to 2 000 mm ² /s 0,031 to 3,100 in ² /s
Operating temperature	-20 to +80 °C; -4 to +176 °F
Operating pressure	min. 20 bar; 290 psi max. 80 bar; 1 160 psi
Relief pressure	≤1 bar; 14,5 psi
Materials	zinc die-cast, brass, copper, steel, NBR
Connection main line	different fittings for pipe Ø 6 to 12 mm; 0,236 to 0,472 in or closure plugs for thread M12×1
Connection outlet	pipe Ø 4 mm; 0,16 in - metering nipple (VS) with SKF Quick Connector - metering nipple (00) for solderless pipe connection (DIN 3862)
Dimensions	min. 37 × 75 × 50,5 mm max. 88 × 75 × 56,5 mm min. 1,456 × 2,952 × 1,988 in max. 3,464 × 2,952 × 2,224 in
Mounting position	any

NOTE

Further technical information, technical drawings, accessories, spare parts or product function descriptions available on SKF.com/lubrication:

1-5001-EN



3D

skf-lubrication.partcommunity.com/3d-cad-models

Metering device

370

Identification code 3 7 - 2 - - - - -

Product series

Number of metering points
 2 = 2 outlets
 3 = 3 outlets
 5 = 5 outlets

Lubrication line fitting
 00 = Solderless pipe connection
 VS = SKF Quick Connector

Metering quantity
 3 = 0,05 cm³, 0.0030 in³
 4 = 0,10 cm³, 0.0061 in³
 5 = 0,20 cm³, 0.0122 in³
 6 = 0,40 cm³, 0.0244 in³
 7 = 0,60 cm³, 0.0366 in³
 8 = 1,00 cm³, 0.0610 in³
 9 = 1,50 cm³, 0.0915 in³

Fittings for main line connection
 B = Solderless pipe connection Ø 6 mm, 0.23 in.
 C = Solderless pipe connection Ø 8 mm, 0.31 in.
 D = Solderless pipe connection Ø 10 mm, 0.39 in.
 E = Banjo fitting DIN 3862 with flat washer, lockable Ø 6 mm, 0.23 in.
 F = Banjo fitting DIN 3862 with flat washer, lockable Ø 8 mm, 0.31 in.
 H = Screw plug with flat washer
 M = Straight adapter with EO-2 functional nut Ø 6 mm, 0.23 in.
 N = Straight adapter with EO-2 functional nut Ø 8 mm, 0.31 in.
 P = Straight adapter with EO-2 functional nut Ø 10 mm, 0.39 in.
 R = Straight adapter with EO-2 functional nut Ø 12 mm, 0.47 in.
 S = Straight adapter with SKF Quick Connector Ø 6 mm, 0.23 in.
 T = Straight adapter with SKF Quick Connector Ø 8 mm, 0.31 in.
 W = Banjo fitting with SKF Quick Connector Ø 6 mm, 0.23 in.
 X = Banjo fitting with SKF Quick Connector Ø 8 mm, 0.31 in.
 Z = Without fitting, solderless pipe connection

Accessory

Exchangeable metering nipples

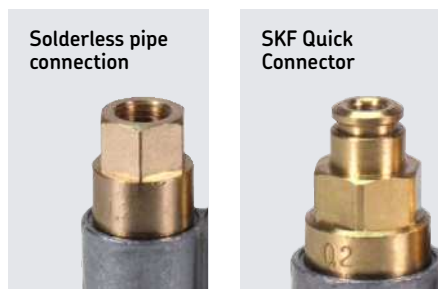

Order numbers for metering nipples* (replaceable)

Outlet Ø		Elastomer	Metering quantity						
mm	in		0,05 cm ³ 0.003 in ³	0,10 cm ³ 0.006 in ³	0,20 cm ³ 0.012 in ³	0,40 cm ³ 0.024 in ³	0,60 cm ³ 0.036 in ³	1,00 cm ³ 0.061 in ³	1,50 cm ³ 0.092 in ³
4	0.157	NBR	V72-005	V71-010	V71-020	V71-040	V71-060	V71-100	V71-150

* Metering nipples are made of brass.

Metering device

391

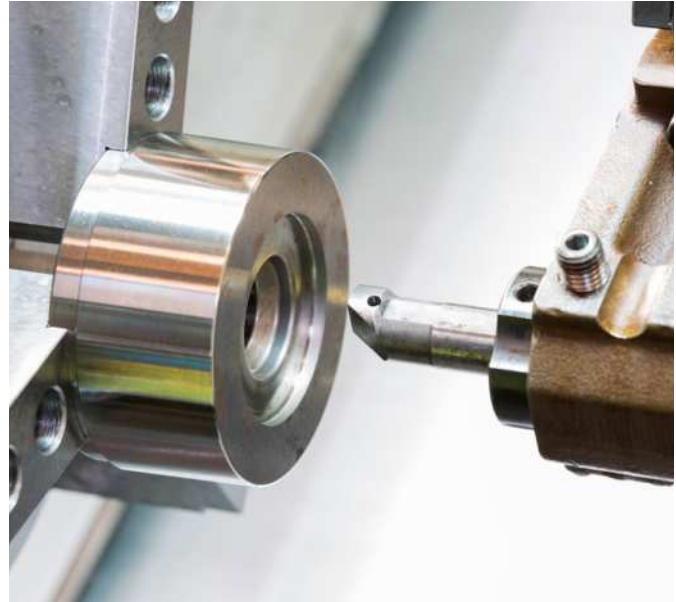

Description

Series 391 single-port prelubrication metering devices were developed for use with single-line, centralized lubrication systems for oil and fluid grease. Designed for installation in manifolds, these metering devices provide flexible system design when combined with one- to six-port manifolds. Customized manifolds for series 391 are available in aluminum.

Features and benefits

- For use with manifolds having one to six ports to match number of lubrication points
- Provides flexible options for systems with remote single lubrication points or multiple-port metering devices with up to six ports
- Select screw-in type metering nipples with feed line connections via order code
- Choose separately manifold models with different thread sizes for main line connection
- Current metering nipples are exchangeable to yield different output quantities

Applications

- Machine tools
- Printing machines
- Packaging industry
- Textile industry

Technical data

Function principle	metering device
Outlets	1
Metering quantity	oil: 0,2 to 1,5 cm ³ ; 0.01 to 0.09 in ³ fluid grease: 0,1 to 0,3 cm ³ 0.006 to 0.02 in ³
Lubricant	mineral and synthetic oil, 20 to 2 000 mm ² /s, fluid grease NLGI 000, 00
Operating temperature	0 to +80 °C; +32 to +176 °F
Operating pressure	min. 8 bar, 116 psi max. 45 bar, 653 psi
Relief pressure	max. 7 bar; 1 01.5 psi
Materials	aluminum, brass (oil), nickel-plated brass (fluid grease), copper, FKM (FPM)/NBR
Connection main line	pipe Ø 6 to 12 mm 0.236 to 0.472 in solderless pipe connection for threads G 1/8; G 1/4; M10×1 or M14×1,5 (DIN 3862)
Connection outlet	pipe Ø 4 mm; 0.16 in - metering nipple (00) for solderless pipe connection
Dimensions	min. 67,5 × 22 mm max. 78,5 × 22 mm min. 2.657 × 0.866 in max. 3.091 × 0.866 in
Mounting position	any



NOTE

Further technical information, technical drawings, accessories, spare parts or product function descriptions available on SKF.com/lubrication:

1-5001-EN



3D

skf-lubrication.partcommunity.com/3d-cad-models

Metering device

391

Identification code: **3 9 1 - 0 0 - 0 0 0 0 - 0 0**

Product series: 391

Number of metering points (1): 00

Design and metering quantity:

Design code	0	8	1
Lubricant	Oil	Oil	Fluid grease
Ø Outlet [mm]	4	4	4
Distributor body	Aluminum	Aluminum	Aluminum
Metering nipple	Brass	Brass	Brass, nickel-plated
Elastomer	NBR	FKM (FPM)	NBR
Threaded seal	Flat washer*	Flat washer*	Flat washer*
Connection outlet	00	00	00
Metering quantity code	0,10 cm ³ -	-	4
	0,20 cm ³ 5	5	5
	0,30 cm ³ -	-	6
	0,40 cm ³ 6	6	-
	0,60 cm ³ 7	7	-
	1,00 cm ³ 8	8	-
	1,50 cm ³ 9	9	-

* Flat washer must be ordered separately. Order number: **DIN7603-A14x18-CU**

Accessory

Manifold



Description

For 391 metering devices, VL-manifolds are utilized for one to six screw-in points with thread M14x1,5 mm for flat (copper) washer sealing. Various main line connections can be selected via order code.

Identification code: **V L - C A**

Product series: VL

Number of ports:

- 01 = 1 screw-in point
- 02 = 2 screw-in points
- 03 = 3 screw-in points
- 04 = 4 screw-in points
- 05 = 5 screw-in points
- 06 = 6 screw-in points

(other numbers of ports available on request)

Design of metering device pipe thread: C = Normal profile, M14x1,5 with counterbore for flat washer

Material: A = Aluminum

Design of main line connection:

- G1 = G1/8 per DIN 3852-2, Form X, small
- G2 = G1/4 per DIN 3852-2, Form X, small
- M3 = M10x1 with counterbore for solderless pipe connection per DIN 3862
- M4 = M14x1,5 with counterbore for solderless pipe connection per DIN 3862 (can only be selected for normal profile)

Metering device

390



Description

Series 390 prelubrication metering devices were developed for use with single-line, centralized lubrication systems for oil and fluid grease. Designed for installation directly on the machine/system requiring lubrication, these metering devices can be ordered with fittings for the main line connection by selecting the appropriate order code.

Features and benefits

- For use with distributor bodies having two or three ports to match number of lubrication points
- Designed for installation directly on the machine/system requiring lubrication
- Select screw-in type metering nipples for feed line connections
- Choose push-in or screw-in type main line fittings
- Current metering nipples are exchangeable to yield different output quantities

Applications

- Machine tools
- Printing machines
- Packaging industry
- Textile industry

Technical data

Function principle	metering device
Outlets	2 or 3
Metering quantity	oil: 0,2 to 1,5 cm ³ 0,01 to 0,915 in ³ fluid grease: 0,1 to 0,3 cm ³ 0,006 to 0,0183 in ³
Lubricant	mineral and synthetic oil 20 to 2 000 mm ² /s 0,031 to 3,100 in ² /s fluid grease of NLGI 000, 00
Operating temperature	0 to +80 °C; +32 to +176 °F
Operating pressure	min. 8 bar, 116 psi max. 45 bar, 653 psi
Relief pressure	max. 7 bar, 1 01.5 psi
Materials	zinc die-cast, brass (oil), nickel-plated brass (fluid grease), copper, steel, FKM (FPM)/NBR
Connection main line	different fittings for pipe Ø 6 to 12 mm; 0.236 to 0.472 in or closure plugs for thread M12×1
Connection outlet	pipe Ø 4 mm; 0.16 in - metering nipple (00) for solderless pipe connection (DIN 3862)
Dimensions	min. 50 × 89 × 23 mm max. 71 × 89 × 23 mm min. 1.968 × 3.503 × 0.905 in max. 5.393 × 3.503 × 0.905 in
Mounting position	any



NOTE

Further technical information, technical drawings, accessories, spare parts or product function descriptions available on SKF.com/lubrication:

1-5001-EN



3D

skf-lubrication.partcommunity.com/3d-cad-models

Metering device

390

Identification code: 3 9 - 0 0 - 0 0 -

Product series: 3 9

Number of metering points (2, 3): 0 0

Design and metering quantity

Design code	0	8	1
Lubricant	Oil	Oil	Fluid grease
Ø Outlet [mm]	4	4	4
Distributor body	Zinc die-cast	Zinc die-cast	Zinc die-cast
Metering nipple	Brass	Brass	Brass (n.p.)
Elastomer	NBR	FKM (FPM)	NBR
Connection outlet	00	00	00
Metering quantity code			
0,10 cm ³	-	-	4
0,20 cm ³	5	5	5
0,30 cm ³	-	-	6
0,40 cm ³	6	6	-
0,60 cm ³	7	7	-
1,00 cm ³	8	8	-
1,50 cm ³	9	9	-
closed*	V	V	V

* V = Metering quantity of 0,20 cm³, closed

Fittings for main line connection

Designation	Main line [mm]	Code
Straight adapter	6	B
DIN 3862 with flat washer	8	C
	10	D
Banjo fitting DIN 3862	6	E
with flat washer, lockable ¹⁾	8	F
Screw plug with flat washer	-	H
	6	M
Straight adapter	8	N
with EO-2 functional nut	10	P
	12	R
Straight adapter	6	S
with SKF Quick Connector	8	T
Banjo fitting with	6	W
SKF Quick Connectors, not lockable	8	X
Without fitting (M12x1 thread)	-	Z

¹⁾ Banjo bolt only inserted in delivery condition, not tightened

Accessory

Exchangeable metering nipples

Order numbers for metering nipples for oil (replaceable)

Outlet Ø	Material elastomer	Metering nipple	Metering quantity
mm in			0,2 cm ³ 0.012 in ³ 0,4 cm ³ 0.024 in ³ 0,6 cm ³ 0.036 in ³ 1,0 cm ³ 0.061 in ³ 1,5 cm ³ 0.092 in ³
4 0.16	NBR	brass	391-020-K 391-040-K 391-060-K 391-100-K 391-150-K
4 0.16	FKM (FPM)	brass	391-020-K-S8 391-040-K-S8 391-060-K-S8 391-100-K-S8 391-150-K-S8

Order numbers for metering nipples for fluid grease (replaceable)

Outlet Ø	Material elastomer	Metering nipple	Metering quantity
mm in			0,10 cm ³ 0.006 in ³ 0,20 cm ³ 0.012 in ³ 0,30 cm ³ 0.018 in ³
4 0.16	NBR	brass, nickel-plated	391-010-K-S1 391-020-K-S1 391-030-K-S1

Metering device

321 G, T, W, G4, Module, G7



Description

Series 321 single-port prelubrication metering devices were developed for use with single-line, centralized lubrication systems for oil and fluid grease. These metering devices are designed for installation directly in a lubrication point, which eliminates feeding lubricant via a lubrication point line, as well as the lubrication line at the lubrication point. This can be beneficial where space is limited. Choose from six types to meet application requirements.

Features and benefits

- Specially designed, single-port metering device for prelubrication
- For direct connection to the main line
- No separate lubrication line and fittings are necessary
- Screw-in type can be monitored by a pressure switch in the main line; suitable for feed line \varnothing 4 mm (oil) and \varnothing 6 mm (fluid grease)

Applications

- Machine tools
- Printing machines
- Packaging industry
- Textile industry



NOTE

Further technical information, technical drawings, accessories, spare parts or product function descriptions available on SKF.com/lubrication:

1-5001-EN



3D

skf-lubrication.partcommunity.com/3d-cad-models

Technical data

Function principle	metering device
Outlets	1
Metering quantity	Model G, G4, T, W, Modular: 0,01 to 0,10 cm ³ ; 0,0006 to 0,006 in ³ Model G7: 0,01 to 0,3 cm ³ 0,0006 to 0,018 in ³
Lubricant	mineral and synthetic oil, 20 to 2 000 mm ² /s, 0,031 to 3.100 in ² /s fluid grease of NLGI 000, 00,0
Operating temperature	0 to +80 °C; +32 to +176 °F
Operating pressure	min. 12 bar, 174 psi max. 45 bar, 653 psi
Relief pressure	max. 3 bar, max. 43.5 psi
Materials	steel (galvanized, Cr6-free) or brass, NBR, G7 FKM (FPM)
Connection main line	different fittings for pipe \varnothing 6 to 10 mm; 0,236 to 0,393 in or closure plugs for thread M 10×1
Connection outlet	pipe \varnothing 4 and \varnothing 6 mm; 0,157 to 0,236 in - straight compression nut fitting - solderless pipe union (DIN 3862)
Dimensions: 321 G	length: 50 mm; 1.968 in \varnothing : 16,2 mm; 0.638 in wrench size 14 mm
Dimensions: 321 W	length: 46 mm; 1.811 in width: 26 mm; 1.023 in \varnothing : 11,5 mm; 0.453 in wrench size 10 mm
Dimensions: 321 G4	length: 40,5 mm; 1.594 in \varnothing : 19,6 mm; 0.771 in wrench size 17 mm
Dimensions: 321 T	length: 43 mm; 1.692 in width: 61 mm; 2.401 in \varnothing : 16,2 mm; 0.638 in wrench size 14 mm
Dimensions: 321 Module	\varnothing : 30 mm; 1.181 in height or thickness: 11 mm; 0.433 in
Dimensions: 321 G7 small	length: 30 mm; 1.181 in \varnothing : 10,3 mm; 0.405 in
Dimensions: 321 G7 large	length: 50 mm; 1.968 in \varnothing : 13,5 mm; 0.531 in
Mounting position	any

Metering device

321 G, T, W, G4, Module, G7

Order information			Outlet Ø		Lubricant		Metering quantity		Pipe thread of lubrication point line
Order number			mm	in	Oil	Fluid grease	cm ³	in ³	
321 G	321 T	321 W							
321-401G1	–	–	4	0.157	•	–	0,01	0.0006	M8×1 taper
321-401G2	321-401T2	321-401W2	4	0.157	•	–	0,01	0.0006	M10×1 taper
321-401G3	–	–	4	0.157	•	–	0,01	0.0006	R 1/8 taper
321-403G1	321-403T1	321-403W1	4	0.157	•	–	0,03	0.0018	M8×1 taper
321-403G2	321-403T2	321-403W2	4	0.157	•	–	0,03	0.0018	M10×1 taper
321-403G3	321-403T3	321-403W3	4	0.157	•	–	0,03	0.0018	R 1/8 taper
321-406G1	321-406T1	321-406W1	4	0.157	•	–	0,06	0.0036	M8×1 taper
321-406G2	321-406T2	321-406W2	4	0.157	•	–	0,06	0.0036	M10×1 taper
321-406G3	321-406T3	321-406W3	4	0.157	•	–	0,06	0.0036	R 1/8 taper
321-410G1	321-410T1	321-410W1	4	0.157	•	–	0,10	0.0061	M8×1 taper
321-410G2	321-410T2	321-410W2	4	0.157	•	–	0,10	0.0061	M10×1 taper
321-410G3	321-410T3	321-410W3	4	0.157	•	–	0,10	0.0061	R 1/8 taper
321-601G1	–	321-601W1	6	0.236	•	•	0,01	0.0006	M8×1 taper
321-601G2	321-601T2	321-601W2	6	0.236	•	•	0,01	0.0006	M10×1 taper
–	321-601T3	321-601W3	6	0.236	•	•	0,01	0.0006	R 1/8 taper
321-603G1	321-603T1	321-603W1	6	0.236	•	•	0,03	0.0018	M8×1 taper
321-603G2	321-603T2	321-603W2	6	0.236	•	•	0,03	0.0018	M10×1 taper
321-603G3	321-603T3	321-603W3	6	0.236	•	•	0,03	0.0018	R 1/8 taper
321-606G1	–	321-606W1	6	0.236	•	•	0,06	0.0036	M8×1 taper
321-606G2	321-606T2	321-606W2	6	0.236	•	•	0,06	0.0036	M10×1 taper
321-606G3	321-606T3	321-606W3	6	0.236	•	•	0,06	0.0036	R 1/8 taper
321-610G1	321-610T1	321-610W1	6	0.236	•	•	0,10	0.0061	M8×1 taper
321-610G2	321-610T2	321-610W2	6	0.236	•	•	0,10	0.0061	M10×1 taper
321-610G3	321-610T3	321-610W3	6	0.236	•	•	0,10	0.0061	R 1/8 taper

* Designs G, T, W elastomer material NBR

Order numbers 321 G4, Module, G7				Outlet Ø		Lubricant		Metering quantity	
Order number				mm	in	Oil	Fluid grease	cm ³	in ³
321 G4	321 Module	321 G7 small	321 G7 large						
–	321-101	321-401G7	–	4	0.157	•	•	0,01	0.0006
321-403G4	321-103	321-403G7	–	4	0.157	•	•	0,03	0.0018
–	–	321-403G7-S8	–	4	0.157	•	•	0,03	0.0018
321-406G4	321-106	321-406G7	–	4	0.157	•	•	0,06	0.0036
–	–	321-406G7-S8	–	4	0.157	•	•	0,06	0.0036
321-410G4	–	321-410G7	321-610G7	4	0.157	•	•	0,10	0.0061
–	–	321-410G7-S8	–	4	0.157	•	•	0,10	0.0061
–	–	–	321-616G7	6	0.236	•	•	0,16	0.0098
–	–	–	321-620G7	6	0.236	•	•	0,20	0.0122
–	–	–	321-630G7	6	0.236	•	•	0,30	0.0180

Metering device

AB



Description

Designed for installation in manifolds, series AB single-port, pre-lubrication metering devices were developed for use with single-line, centralized lubrication systems for oil and fluid grease. When combined with one- to six-port manifolds, these metering devices provide flexibility in lubrication system design. The metering device body is available in steel and stainless steel versions with copper or stainless steel sealing rings.

Features and benefits

- For use with manifolds having one to six ports to match number of lubrication points
- Provides flexible options for systems with remote single lubrication points or multiple-port metering devices with up to six ports
- Virtually maintenance-free
- Select screw-in type metering device for feed line connection via order code
- Choose separately manifold models with different thread sizes for main line connection and materials

Applications

- Machine tools
- Printing machines
- Packaging industry
- Textile industry

Technical data

Function principle	metering device
Outlets	1
Metering quantity	0,01 to 0,60 cm ³ , 0,0006 to 0,04 in ³
Lubricant	mineral and synthetic oil, 20 to 2 000 mm ² /s, 0,031 to 3,100 in ² /s, fluid grease of NLGI 000, 00
Operating temperature	0 to +80 °C; +32 to +176 °F
Operating pressure	min. 18 bar, 260 psi max. 50 bar, 725 psi
Relief pressure	max. 3 bar, 43,5 psi
Materials	steel (galvanized, Cr6-free), stainless steel, copper, steel, flat washer (copper, stainless steel), FKM (FPM)
Connection main line	pipe Ø 6 to 10 mm; 0,236 or 0,393 in; solderless pipe connection for threads G 1/8; G 1/4; M10×1 or M14×1,5 (DIN 3862)
Connection outlet	Connection outlet: pipe Ø 4 mm; 0,16 in, straight compression nut fitting
Dimensions	min. 43 × 14 mm max. 82,5 × 14 mm min. 1,692 × 0,551 in max. 1,228 × 0,551 in
Mounting position	any



NOTE

Further technical information, technical drawings, accessories, spare parts or product function descriptions available on SKF.com/lubrication:

1-5001-EN



3D

skf-lubrication.partcommunity.com/3d-cad-models

Metering device

AB

Identification code	2 4 - 2 8 0 0 - 0
Product series AB	
Lubricant	
Metering quantity	

5 = Oil/fluid grease, galvanized steel, copper ring
 9 = Oil/fluid grease, stainless steel, stainless steel ring

Metering quantity
 01 = 0,01 cm³, 0.0006 in³
 02 = 0,02 cm³, 0.0012 in³
 03 = 0,03 cm³, 0.0018 in³
 05 = 0,05 cm³, 0.0030 in³
 10 = 0,10 cm³, 0.0061 in³
 20 = 0,20 cm³, 0.0122 in³
 40 = 0,40 cm³, 0.0244 in³
 60 = 0,60 cm³, 0.0366 in³

Accessory

Manifold



Description

For series AB metering devices, VL-manifolds are utilized for one to six screw-in points with thread M 10x1 mm for flat (copper) washer sealing. Normal-profile manifolds are available in aluminum or stainless steel, while narrow-profile manifolds are offered only in aluminum. Various main line connections can be selected via order code.

Identification code	V L -
Product series	
Number of ports	
Design of metering device pipe thread	
Material	
Design of main line connection	

Number of ports
 01 = 1 screw-in point 04 = 4 screw-in points
 02 = 2 screw-in points 05 = 5 screw-in points
 03 = 3 screw-in points 06 = 6 screw-in points
 (other numbers of ports available on request)

Design of metering device pipe thread
 B = Normal profile, M10x1 with counterbore for flat washer or O-ring

Material
 A = Aluminum E = Stainless steel (1.4305) (can only be selected for normal profile)

Design of main line connection
 G1 = G1/8 per DIN 3852-2, Form X, small
 G2 = G1/4 per DIN 3852-2, Form X, small
 M3 = M10x1 with counterbore for solderless pipe connection per DIN 3862
 M4 = M14x1,5 with counterbore for solderless pipe connection per DIN 3862
 (can only be selected for normal profile)

Metering device

VN



Description

Developed for use with single-line, centralized lubrication systems for fluid grease, series VN relubrication metering devices are offered with two, four or six ports. These metering devices were designed for installation directly on the vehicle or construction machine requiring lubrication. Series VN metering devices can be ordered with fittings for the main line connection via the appropriate order code.

Features and benefits

- Choose metering device with two, four or six points to match number of lubrication points
- Designed for installation directly on the vehicle/machine requiring lubrication
- Select metering nipples and push-in or screw-in type fittings for feed line or main line connections
- Easy metering adjustment by replacing metering nipples
- Black-coloured surface for optimized corrosion protection

Applications

- Commercial vehicles
- Construction machinery

Technical data

Function principle	metering device
Outlets	2, 4 or 6
Metering quantity	0,05 to 1,00 cm ³ 0,003 to 0,061 in ³
Lubricant	fluid grease of NLGI 000, 00
Operating temperature	-25 to +80 °C; -13 to +176 °F
Operating pressure	min. 20 bar; 290 psi max. 80 bar; 1 160 psi
Relief pressure	≤1 bar, ≤14.5 psi
Materials	zinc die-cast, brass, steel, flat washer (copper), NBR
Connection main line	different fittings for pipe Ø 6 to 10 mm; 0,236 to 0,393 in or closure plugs for thread M8x1
Connection outlet	pipe Ø 4 mm metering nipple (VS) with SKF Quick Connector - metering nipple (00) for solderless pipe connection
Dimensions	min. 62 × 83,5 × 52 mm max. 130,5 × 83,5 × 58 mm min. 2.440 × 3.287 × 2.047 in max. 5.118 × 3.287 × 2.283 in
Mounting position	any

NOTE

Further technical information, technical drawings, accessories, spare parts or product function descriptions available on SKF.com/lubrication:

1-5001-EN



3D

skf-lubrication.partcommunity.com/3d-cad-models

Metering device

VN

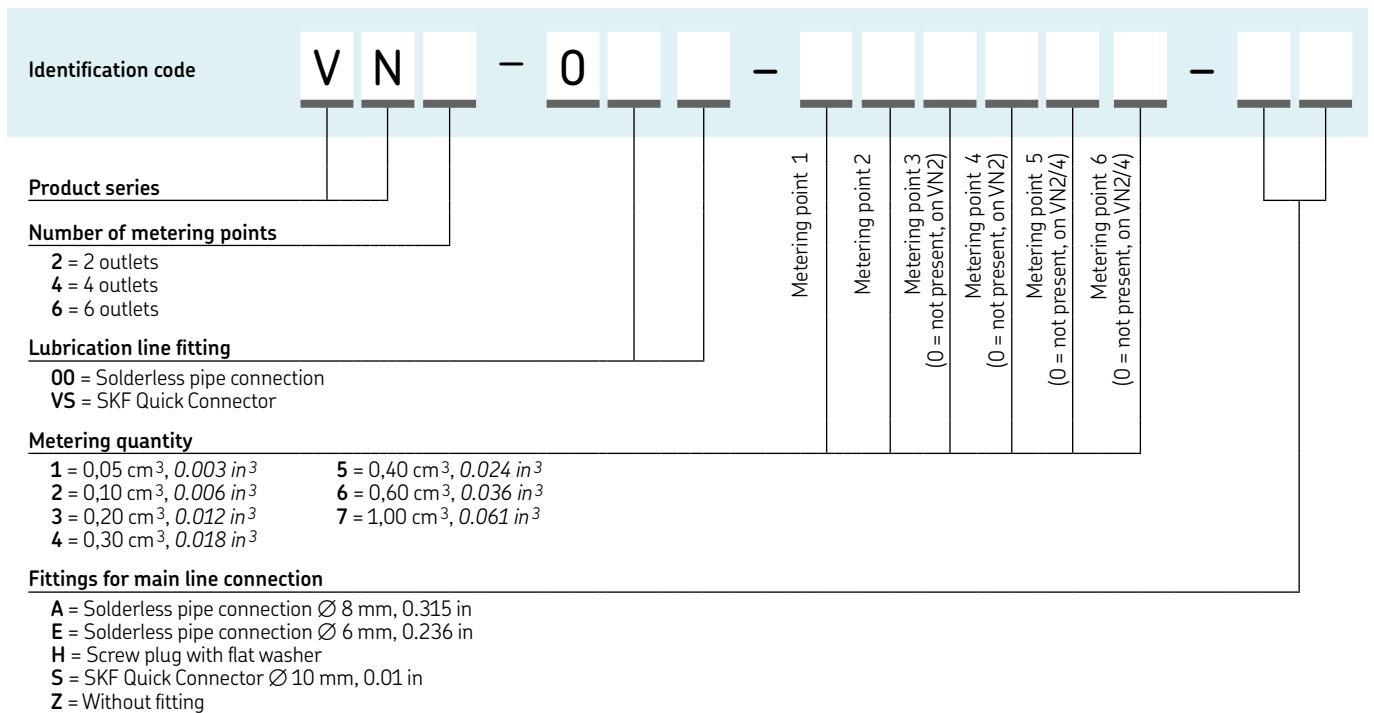

Accessory

Exchangeable metering nipples

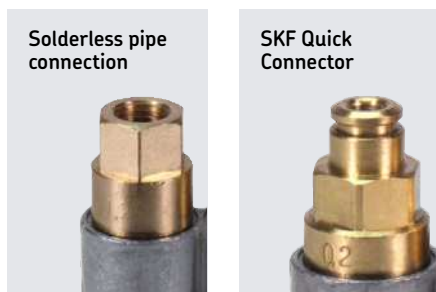

Order numbers for metering nipples* (replaceable)

Outlet Ø		Elastomer	Metering quantity						
mm	in		0,05 cm ³ 0.003 in ³	0,10 cm ³ 0.006 in ³	0,20 cm ³ 0.012 in ³	0,30 cm ³ 0.018 in ³	0,40 cm ³ 0.024 in ³	0,60 cm ³ 0.036 in ³	1,00 cm ³ 0.061 in ³
4	0.16	NBR	VKU005-K	VKU010-K	VKU020-K	VKU030-K	VKU040-K	VKU060-K	VKU100-K

* Metering nipples are made of brass.

Metering device

OI-AL-SR



Description

Developed for use in single-line, centralized lubrication systems, series OI-AL-SR single-port, prelubrication metering devices (cartridges) feature an integrated control pin and are designed for installation in manifolds or in base plates with up to 40 lubrication points. Three cartridge models with different fixed metering quantities provide flexible lubrication system design. Reduced feeding of main lines and feed lines in machines/systems saves on materials and installation costs.

Features and benefits

- Screw-in type, single-port metering device with cartridges for prelubrication
- For use with manifolds having one to eight ports or with base plates with up to 40 ports to match number of lubrication points
- Suitable for many lubrication points in constricted rooms
- All main line and feed line connections are located internally in the manifolds or base plates
- Simplifies installation, control function and replacement by use of one unit

Applications

- Glass industry

Technical data

Function principle	metering device
Outlets	1
Metering quantity	0,02; 0,05; 0,10 cm ³ ; 0,001; 0,003; 0,006 in ³
Lubricant	mineral and synthetic oil, 22 to 1 000 mm ² /s, 0,034 to 1,55 in ² /s, fluid grease of NLGI 000, 00
Operating temperature	+5 to 120 °C; +41 to 248 °F
Operating pressure	min. 30 bar; 435 psi max. 100 bar; 1 450 psi
Relief pressure	max. 5 bar; 72.5 psi
Material cartridge	aluminum
Material manifold	AlCuMgPb F37 DIN 1796
Material base plate	AlMgSi1 F28-32 or AlCuMg1 F28 FKM (FPM)
Connection main line	SKF Quick Connector or solderless pipe connection for thread G 1/8 (F)
Connection outlet	SKF Quick Connector or solderless pipe connection for thread G 1/8 (F)
Dimensions	min. 120 × 35 × 105 mm max. 300 × 35 × 105 mm min. 4.72 × 1.38 × 4.13 in max. 11.81 × 1.38 × 4.13 in
Mounting position	any

NOTE

Further technical information, technical drawings, accessories, spare parts or product function descriptions available on SKF.com/lubrication:

951-231-001



3D

skf-lubrication.partcommunity.com/3d-cad-models

Metering device

OI-AL-SR

Order information

Order number	Number of outlets	Metering quantity															
		Outlet 1		Outlet 2		Outlet 3		Outlet 4		Outlet 5		Outlet 6		Outlet 7		Outlet 8	
		cm ³	in ³	cm ³	in ³	cm ³	in ³	cm ³	in ³	cm ³	in ³	cm ³	in ³	cm ³	in ³	cm ³	in ³
647-41151-2	2	0,02	0.001	0,02	0.001	-	-	-	-	-	-	-	-	-	-	-	-
647-41152-2	3	0,02	0.001	0,02	0.001	0,02	0.001	-	-	-	-	-	-	-	-	-	-
647-41152-4	3	0,10	0.006	0,05	0.003	0,05	0.003	-	-	-	-	-	-	-	-	-	-
647-41153-2	4	0,05	0.003	0,05	0.003	0,05	0.003	-	-	-	-	-	-	-	-	-	-
647-41154-4	5	0,02	0.001	0,02	0.001	0,02	0.001	0,02	0.001	0,02	0.001	-	-	-	-	-	-
647-41154-5	5	0,02	0.001	0,02	0.001	0,02	0.001	0,02	0.001	-	-	-	-	-	-	-	-
647-41154-7	5	0,02	0.001	0,05	0.003	0,05	0.003	0,05	0.003	0,05	0.003	-	-	-	-	-	-
647-41154-6	5	0,05	0.003	0,05	0.003	0,05	0.003	0,05	0.003	-	-	-	-	-	-	-	-
647-41155-2	6	0,10	0.006	0,05	0.003	0,05	0.003	0,05	0.003	0,05	0.003	0,05	0.003	-	-	-	-
647-41156-2	8	0,05	0.003	0,05	0.003	0,05	0.003	0,05	0.003	0,02	0.001	0,02	0.001	0,02	0.001	-	-

Accessories

Cartridges, manifolds and base plates

Cartridge



Manifold

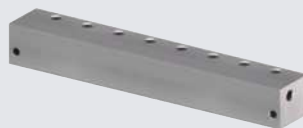

Base plate



Cartridges

Order number	Metering quantity
547-33924-1	0,02 cm ³ /stroke
547-33925-1	0,05 cm ³ /stroke
547-33926-1	0,10 cm ³ /stroke

Manifolds

Order number	Number of ports
447-71901-1	2
447-71902-1	3
447-71903-1	4
447-71904-1	5
447-71905-1	6
447-71906-1	8

Baseplates

Order number	Number of ports
447-71899-1	40

Metering device

SL-42

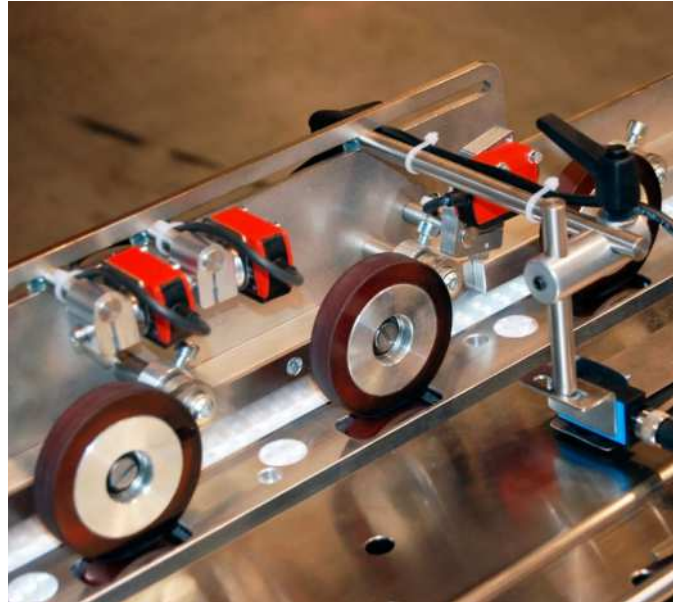

Description

Series SL-42 metering devices were developed for single-line, centralized lubrication systems dispensing oil or fluid grease. Lubricant output is externally adjustable, and the indicator stem permits a visual check of metering device operation. These carbon steel metering devices are available with nitrile or fluoroelastomer packings. Metering devices with fluoroelastomer packings (indicated by black adjustment caps) are used for applications requiring heat resistance or when a lubricant requires it for compatibility.

Features and benefits

- Screw-in type, single-port metering device for prelubrication affixed by adapter bolts
- Suitable for use with manifolds having one to 15 ports to match number of lubrication points
- Output is externally adjustable
- Indicator stem permits visual check of metering device operation
- May be combined in a circuit with SL-41, SL-43 and/or SL-44 metering devices
- Individual metering devices can be removed easily for inspection or replacement

Applications

- Paper converting
- Plastic processing
- Printing
- Packaging
- Metalworking
- Material handling equipment

Technical data

Function principle	metering device
Outlets	1
Metering quantity	adjustable from 0,016 to 0,049 cm ³ , 0,001 to 0,003 in ³
Lubricant	mineral and synthetic oil and fluid grease
Operating temperature	standard: -26 to +93 °C; -15 to +200 °F heat resistant: max. +176 °C; +350 °F
Operating pressure	min. 52 bar, 750 psi max. 70 bar, 1 000 psi
Relief pressure	< 10 bar, 150 psi
Materials	carbon steel, stainless steel, brass, steel, Nitrile (NBR) or fluoroelastomer (FKM, FPM) packings (indicated by black adjustment caps) (heat resistance application)
Connection main line	1/8 NPTF (F)
Connection outlet	pipe 1/8 O.D connections ¹⁾
Dimensions	min. 41 × 62 × 43 mm max. 308 × 62 × 43 mm min. 1.6 × 2.4 × 1.7 in max. 12.1 × 2.4 × 1.7 in
Mounting position	any

¹⁾ Different adapters are possible → see accessories
Note: When using feed line tubing of 1/8 O.D. the feed line must not exceed a length of 7,5 m; 295 in based on oil +18 °C; +65 °F



NOTE

Further technical information, technical drawings, accessories, spare parts or product function descriptions available on SKF.com/lubrication.

Metering device

SL-42

Identification code

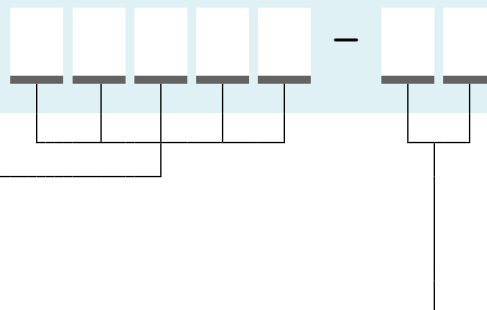

Product series

- 83311 = SL-42 standard with nitrile packings
- 84428 = SL-42 heat resistant with fluoroelastomer packings
- 85352 = SL-42 standard with nitrile packings for metric tube connection
O.D. 4 and 6 mm

Number of metering devices

- 1 = 1 metering device, mounted in a manifold
- 2 = 2 metering devices, mounted in a manifold
- 3 = 3 metering devices, mounted in a manifold
- 4 = 4 metering devices, mounted in a manifold
- 5 = 5 metering devices, mounted in a manifold
- 6 = 6 metering devices, mounted in a manifold
- 10 = 10 metering devices, mounted in a manifold
- 15 = 15 metering devices, mounted in a manifold

Accessories

Metering devices, manifolds and adapters

Metering device



Manifold



This picture shows a manifold example. Please note, the real manifold differs in terms of size and design.

Adapter



Replacement for manifold injectors

Order number	Designation
83535	standard single metering device/no manifold, 1 outlet, 1/8 NPTF (M) inlet
83313	metering device for standard manifold
84048	metering device for heat-resistant manifold
249649	metric replacement injector

Manifolds

Order number ¹⁾	Number of ports
91863-1	1
91864-1	2
91865-1	3
91866-1	4
14361	5
91976-1	6
14312	10
14253	15

¹⁾ Injectors, except replacement injectors for manifold, include compression nut and ferrule for tubing 1/8 in O.D. as standard. Injectors with manifolds include two mounting clips and screws.

G 1/8 to metric fitting adapters

Order number	Pipe Ø mm	Material
249281	4	steel
249279	4	stainless steel
249282	6	steel
249280	6	stainless steel

Metering device

SL-43



Description

Series SL-43 metering devices were developed for single-line, centralized lubrication systems dispensing oil or fluid grease. Lubricant output is externally adjustable, and the indicator stem permits a visual check of metering device operation. These carbon steel metering devices are available with nitrile or fluoroelastomer packings. Metering devices with fluoroelastomer packings (indicated by black adjustment caps) are used for applications requiring heat resistance or when a lubricant requires it for compatibility.

Features and benefits

- Screw-in type, single-port metering device for prelubrication affixed by adapter bolts
- Suitable for use with manifolds having one to four ports to match number of lubrication points
- Output is externally adjustable
- Indicator stem permits visual check of metering device operation
- May be combined in a circuit with SL-41, SL-42 and/or SL-44 metering devices
- Individual metering devices can be removed easily for inspection or replacement

Applications

- Glass processing
- Paper converting
- Plastic processing
- Printing and packaging
- Metalworking
- Material handling equipment



Technical data

Function principle	metering device
Outlets	1
Metering quantity	adjustable from 0,016 to 0,131 cm ³ 0.001 to 0.008 in ³
Lubricant	mineral and synthetic oil
Operating temperature	standard: -26 to +93 °C; -15 to +200 °F heat resistant: max. +176 °C; +350 °F
Operating pressure	min. 52 bar, 750 psi max. 70 bar; 1 000 psi
Relief pressure	< 10 bar, 150 psi
Materials	carbon steel, stainless steel, brass, steel, Nitrile (NBR) or fluoroelastomer (FKM, FPM) packings (indicated by black adjustment caps) (heat resistance application)
Connection main line	1/4 NPTF (F)
Connection outlet	pipe 1/8 O.D connections ¹⁾
Dimensions	min. 44 × 79 × 52 mm max. 102 × 79 × 52 mm min. 1.7 × 3.1 × 2.0 in max. 4.0 × 3.1 × 2.0 in
Mounting position	any

¹⁾ Different adapters are possible → see accessories
Note: When using feed line tubing of 1/8 O.D. the feed line must not exceed a length of 7,5 m; 295 in based on oil +18 °C; +65 °F



NOTE

Further technical information, technical drawings, accessories, spare parts or product function descriptions available on SKF.com/lubrication.

Metering device

SL-43

Identification code

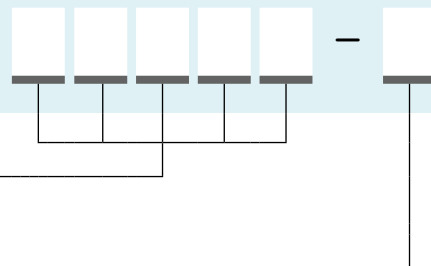

Product series

- 83661 = SL-43 standard with nitrile packings
- 84429 = SL-43 heat resistant with fluoroelastomer packings

Number of metering devices

- 1 = 1 metering device, mounted in a manifold
- 2 = 2 metering devices, mounted in a manifold
- 3 = 3 metering devices, mounted in a manifold
- 4 = 4 metering devices, mounted in a manifold

Accessories

Metering devices, manifolds and adapters

Metering device



Manifold



This picture shows a manifold example. Please note, the real manifold differs in terms of size and design.

Adapter



Replacement for manifold injectors

Order number	Designation
83662	standard single metering device/no manifold, 1 outlet, 1/8 NPTF (M) inlet
83660	metering device for standard manifold
84110	metering device for heat-resistant manifold

Manifolds

Order number ¹⁾	Number of ports
91883-1	1
91884-1	2
91885-1	3
91886-1	4

¹⁾ Injectors, except replacement injectors for manifold, include compression nut and ferrule for tubing 1/8 in O.D. as standard. Injectors with manifolds include two mounting clips and screws.

G 1/8 to metric fitting adapters

Order number	Pipe Ø mm	Material
249281	4	steel
249279	4	stainless steel
249282	6	steel
249280	6	stainless steel

Metering device

SL-41



Description

Series SL-41 metering devices are designed for use in high-temperature applications, depending on the lubricant. These metering devices are available installed only in manifolds with 3/8-inch NPT female inlets and feature a tamper-resistant adjustment screw that does not incorporate a visual indicator.

Features and benefits

- Screw-in type, single-port metering device affixed by adapter bolts
- Suitable for use with manifolds having one to five ports to match number of lubrication points
- Output is externally adjustable.
- Individual injectors can be removed easily for inspection or replacement
- Carbon steel with fluoroelastomer packings

Applications

- Glass processing
- Metalworking

Technical data

Function principle	metering device
Outlets	1 to 5
Metering quantity	adjustable from 0,13 to 1,31 cm ³ 0.008 to 0.0689 in ³
Lubricant	mineral and synthetic oil
Operating temperature	standard: -26 to +93 °C; -15 to +200 °F heat resistant: max. +176 °C; +350 °F
Operating pressure	min. 52 bar; 750 psi max. 70 bar; 1 000 psi
Relief pressure	< 10 bar; 150 psi
Materials	carbon steel, FKM (FPM)
Connection main line	3/8 NPTF (F)
Connection outlet	1/8 NPTF (F) ¹⁾
Dimensions	min. 63 × 163,5 × 52,4 mm max. 171 × 163,5 × 52,4 mm min. 2.5 × 6.4 × 2.1 in max. 6.75 × 6.4 × 2.1 in
Mounting position	any

¹⁾ When using feed line tubing of 1/8 O.D., feed line must not exceed a length of 7,5 m; 295 in based on oil +18 °C; +64 °F 1/8 NPTF (F).

NOTE

Further technical information, technical drawings, accessories, spare parts or product function descriptions available on SKF.com/lubrication.

Metering device

SL-41

Identification code 8 2 2 9 4 -

Product series
82294 = SL-41 heat resistant with fluoroelastomer packings

Number of metering devices

- 1 = 1 metering device, mounted in a manifold
- 2 = 2 metering devices, mounted in a manifold
- 3 = 3 metering devices, mounted in a manifold
- 4 = 4 metering devices, mounted in a manifold
- 5 = 5 metering devices, mounted in a manifold

Accessories

Metering devices and manifolds



Replacement for manifold injectors

Order number	Designation
82295	metering device for manifold NPTF (F)
82292	single metering device

Manifolds

Order number ¹⁾	Number of ports
12658	1
11962	2
11963	3
11964	4
11965	5

¹⁾ Each injector has two outlets. One is closed by a closure plug, but can be used to increase outlet quantity combined with another injector.

Metering device

SL-44



Description

Series SL-44 metering devices were developed for single-line, centralized lubrication systems dispensing fluid or semi-fluid lubricants. Lubricant output is externally adjustable, and the indicator stem permits a visual check of metering device operation. These carbon steel metering devices feature fluoroelastomer packings. Metering devices with fluoroelastomer packings (indicated by black adjustment caps) are used for applications requiring heat resistance or when a lubricant requires it for compatibility.

Features and benefits

- Screw-in type, single-port metering device for prelubrication affixed by adapter bolts
- Suitable for use with manifolds having one to five ports to match number of lubrication points
- Output is externally adjustable
- Indicator stem permits visual check of operation
- May be combined in a circuit with SL-41, SL-42 and/or SL-43 metering devices
- Individual metering devices can be removed easily for inspection or replacement

Applications

- Glass processing
- Paper converting
- Plastic processing
- Printing
- Packaging
- Metalworking
- Material handling equipment



Technical data

Function principle	metering device
Outlets	1
Metering quantity	adjustable from 0,13 to 1,31 cm ³ , 0,008 to 0,080 in ³
Lubricant	mineral and synthetic oil
Operating temperature	-26 to +93 °C; -15 to +200 °F
Operating pressure	min. 52 bar, 750 psi max. 70 bar, 1 000 psi
Relief pressure	< 10 bar, 150 psi
Materials	carbon steel, FKM (FPM)
Connection main line	3/8 NPTF (F)
Connection outlet ¹⁾	1/8 NPTF (F)
Dimensions	min. 63 × 179,4 × 52,4 mm max. 171 × 179,4 × 52,4 mm min. 2.5 × 7.1 × 2.1 in max. 6.75 × 7.1 × 2.1 in
Mounting position	any

¹⁾ When using feed line tubing of 1/8 O.D. the feed line must not exceed a length of 7,5 m; 295 in based on oil +18 °C; +65 °F



NOTE

Further technical information, technical drawings, accessories, spare parts or product function descriptions available on SKF.com/lubrication.

Metering device

SL-44

Identification code 8 3 7 4 9 - []

Product series

83749 = SL-44 heat resistant with fluoroelastomer packings

Number of metering devices

- 1 = 1 metering device, mounted in a manifold
- 2 = 2 metering devices, mounted in a manifold
- 3 = 3 metering devices, mounted in a manifold
- 4 = 4 metering devices, mounted in a manifold
- 5 = 5 metering devices, mounted in a manifold

Accessories

Metering devices and manifolds

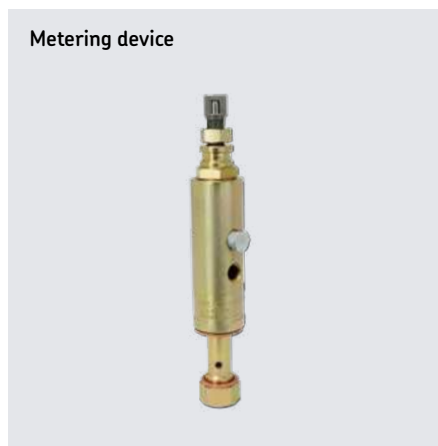

Replacement for manifold injectors

Order number	Designation
83748	metering device for manifold NPTF (F)

Manifolds

Order number ¹⁾	Number of ports
12658	1
11962	2
11963	3
11964	4
11965	5

¹⁾ Each injector has two outlets. One is closed by a closure plug, but can be used to increase outlet quantity combined with another injector.



Overview of grease metering devices

Single-line metering devices

Product	Cate- gory ¹⁾	Lubricant grease NLGI			Metering quantity		Operating pressure max.		Relief pressure max.		Adjustable metering quantity	Function type	Page
		0	1	2	cm ³ /stroke	in ³ /stroke	bar	psi	bar	psi			
SL-33	2)	5	• • –	0,016–0,05	0.0009–0.0030	83–240	1 200–3 500	14	200	•	prelubrication	132	
B-doser	2)	5	• • –	0,02–0,50	0.0012–0.0305	max. 150	max. 2 180	15 ³⁾	218 ³⁾	•	prelubrication	134	
LG-doser	2)	5	• • –	0,02–0,50	0.0012–0.0305	max. 150	max. 2 180	10 ³⁾	145 ³⁾	•	prelubrication	136	
SL-32 HV	2)	6	• • •	0,016–0,13	0.0009–0.0079	83–240	1 200–3 500	28	400	•	prelubrication	138	
SL-1	2)	6	• • •	0,13–1,31	0.0079–0.0799	127–240	1 850–3 500	41	600	•	prelubrication	139	
QSL	2)	7	• • •	0,05–0,40	0.0030–0.0244	140–300	2 030–4 350	60	870	•	prelubrication	140	
VR	2)	7	• • •	0,10–1,30	0.0061–0.0793	100–315	1 450–4 570	30 ³⁾	435 ³⁾	•	prelubrication	142	
								70 ³⁾	1 000 ³⁾	•	prelubrication		
SLC		7	• • •	0,10–1,40	0.0061–0.0840	150–315	2 175–4 570	68	990	•	prelubrication	144	
SL-11		7	• • •	0,82–8,20	0.0500–0.5002	70–240	1 000–3 500	55	800	•	prelubrication	146	
SL-V		7	• • •	0,25–1,31	0.0152–0.0799	128–413	1 850–6 000	70	1 000	•	prelubrication	147	
SL-V XL		7	• • •	0,25–5,00	0.0152–0.3050	128–413	1 850–6 000	70	1 000	•	prelubrication	148	

¹⁾ The category allows a simple assignment of the metering device to a pump of the same category. The category results from the relief pressure, the operating principle and the lubricant suitable for the metering device.

²⁾ Stainless steel or C5M available

³⁾ Depending on design

Metering device

SL-33



Description

The series SL-33 metering devices are for single-line, high-pressure centralized lubrication systems dispensing petroleum-based lubricants with a viscosity up to NLGI 2. Output is externally adjustable. Its indicator stem permits visual check of metering device operation. May be combined in a circuit of metering devices SL-32, SL-V, SL-V XL, SL-1 and/or SL-11. Individual metering devices can be removed easily for inspection or replacement. Available in stainless steel SAE 304 for applications where environmental conditions are hazardous to carbon steel or in industries preferring stainless steel.

Features and benefits

- For use with manifolds from 1 to 7 ports to match number of lube points
- Output is externally adjustable
- Can be removed easily for inspection or replacement

Applications

- Food and beverage

Technical data

Function principle	metering device
Outlets	1 to 4
Metering quantity	0,016 to 0,049 cm ³ 0.001 to 0.003 in ³
Lubricant	grease NLGI 0, 1
Operating temperature	max. +93 °C; +200 °F
Operating pressure	83 to 240 bar, 1 200 to 3 500 psi typical: 100 bar, 1 500 psi
Relief pressure	14 bar, 200 psi
Materials	carbon steel, stainless steel 304
Connection main line	1/8 NPTF (F), 1/8 NPTF (M)
Connection outlet	1/8 in O.D. tube
Lubricant point	solderless pipe connection (DIN 3862) or plug connector
Dimensions	min. 41 × 62 × 43 mm max. 156 × 62 × 43 mm min. 1.6 × 2.4 × 1.7 in max. 6.1 × 2.4 × 1.7 in
Mounting position	any

Metering devices, except replacement metering devices for manifold, include compression nut and ferrule for tubing, 3,175 mm (0.125 in) O.D. as standard. Other outlet connectors for feed line optional; metering devices with manifolds include two mounting clips and screws; metering devices have nitrile packings. Check packing compatibility with synthetic lubricants; output with indicator cap hand-tightened is 0,016 cm³ (0.001 in³). Maximum output is achieved with two turns at 0,016 cm³/turn (0.001 in³/turn)

NOTE

Further technical information, technical drawings, accessories, spare parts or product function descriptions available on SKF.com/lubrication.

Metering device

SL-33

Order information

Order number	Designation	Material	Number of outlets	Manifold inlet
83309-1	metering device including manifold	carbon steel	1	1/8 NPTF (F)
83309-2	metering device including manifold	carbon steel	2	1/8 NPTF (F)
83309-3	metering device including manifold	carbon steel	3	1/8 NPTF (F)
83309-4	metering device including manifold	carbon steel	4	1/8 NPTF (F)
83309-5	metering device including manifold	carbon steel	5	1/8 NPTF (M)
83309-6	metering device including manifold	carbon steel	6	1/8 NPTF (F)
83900	single metering device, no manifold needed	carbon steel	1	1/8 NPTF (M)
83314	single metering device for replacement	carbon steel	–	–
83715-1	metering device including manifold	stainless steel 304	1	1/8 NPTF (F)
83715-2	metering device including manifold	stainless steel 304	2	1/8 NPTF (F)
83715-3	metering device including manifold	stainless steel 304	3	1/8 NPTF (F)
83715-4	metering device including manifold	stainless steel 304	4	1/8 NPTF (F)
83715-6	metering device including manifold	stainless steel 304	6	1/8 NPTF (F)
83715-7	metering device including manifold	stainless steel 304	7	1/8 NPTF (F)
83900-9	single metering device, no manifold needed	stainless steel 304	1	1/8 NPTF (M)
83314-9	single metering device for replacement	stainless steel 304	–	–

Metering device

B-doser



Description

B-dosers are used in single-line, heavy vehicle and industrial lubrication applications. The doser group consists of a mounting rail with one or more dosers attached to it. Dosing modules and mounting rails are made of zinc-coated and yellow-passivated steel. The dosage ranges of B-dosers are from 20 to 500 mm³.

Features and benefits

- The output quantity of the used dosers is visible on amount of notches at the housing
- Suitable with optionally manifold sizes for 2-, 3- and 6-ports to match amount of lube points (1-6)
- Material of manifold : stainless steel AISI 303
- Suits for Ø 4 and 6 mm of feedlines

Applications

- Heavy vehicles
- Heavy industrial application

Technical data

Function principle	metering device
Outlets	1 to 6
Metering quantity	0,02 to 0,50 cm ³ 0,0012 to 0,0305 in ³
Lubricant	oil and grease NLGI 000 to 1
Operating temperature	-25 to +80 °C; -13 to +176 °F
Operating pressure	max. 150 bar; 2 180 psi
Relief pressure	B1, B2=15 bar; 218 psi B3, B4=10 bar; 145 psi B5, B6=5 bar; 72 psi
Materials	zinc-coated and yellow-passivated steel
Connection main line (manifold)	R 1/4 for Ø 8 mm or pipe Ø 1/2 in
Connection outlet	1/8 NPT(F) for Ø 4 and 6 mm feedlines
Lubricant point	solderless pipe connection (DIN 3862)
Dimensions	min. 15 × 90 × 15 mm max. 17 × 110 × 17 mm min. 0.6 × 3.5 × 0.6 in max. 0.7 × 4.3 × 0.7 in
Mounting position	any

NOTE

Further technical information, technical drawings, accessories, spare parts or product function descriptions available on SKF.com/lubrication:

11276 EN



3D

skf-lubrication.partcommunity.com/3d-cad-models

Metering device

B-doser

Identification code B - G 1 / 8 - Z N - []

Product series

Metering quantity

- 1 = 0,02 cm³, 0.0012 in³
- 2 = 0,05 cm³, 0.0030 in³
- 3 = 0,10 cm³, 0.0061 in³
- 4 = 0,15 cm³, 0.0091 in³
- 5 = 0,20 cm³, 0.0122 in³
- 6 = adjustable 0,2 to 0,5 cm³; 0.012 to 0.03 in³

Mounting rail fitting

G1/8 = G1/8 fitting

Material

ZN = zinc-coated steel

Lubricant outlet

- 4 = connector for Ø 4 mm pipe
- 6 = connector for Ø 6 mm pipe
- U = female thread NPT 1/8

Accessory

Manifold



Description

For B-doser metering devices, manifolds utilized are for 1 to 6 screw-in points with thread G 1/8 for O-ring sealing. Mainline fitting for G 1/4 for Ø 8 mm or pipe Ø 1/2 in. Normal profile and opposite-side profile design manifolds are available in zinc-coated and yellow-passivated steel. Various designs of main line and feed line connection can be selected by order code.

Identification code B P L D - [] - Z N

Manifold

Size

- 02 = 2-place mounting rail
- 04 = 4-place mounting rail
- 06 = 6-place mounting rail
- 0202 = 4-place mounting rail, 2 places on opposite sides
- 0303 = 6-place mounting rail, 3 places on opposite sides

Material

ZN = Zinc-coated and yellow-passivated steel

Metering device

LG-doser



Description

LG-dosers are used in single-line lubrication applications. The doser group consists of a mounting rail with one or more dosers attached to it. Dosing modules and mounting rails are made of stainless steel.

Features and benefits

- Two adjustable doser sizes are selectable by the used output quantity
- Manifold material: stainless steel AISI 303
- Compatible with screw-in type fittings for dosers and manifolds
- Suitable for feed line \varnothing 4 and \varnothing 6 mm
- Robust and reliable

Applications

- Food and beverage

Technical data

Function principle	metering device
Outlets	1 to 6
Metering quantity	0,02 to 0,50 cm ³ 0,0012 to 0,0305 in ³
Lubricant	oil and grease NLGI 000 to 1
Operating temperature	-25 to +80 °C; -13 to +176 °F
Operating pressure	max. 150 bar; 2 180 psi
Relief pressure	LG001 = 10 bar; 145 psi LG002 = 5 bar; 72 psi
Materials	stainless steel AISI 304
Connection main line (manifold)	R 1/4 in
Connection outlet	pipe connector \varnothing 4 and 6 mm or pipe \varnothing 1/4 in
Connection lubricant point	solderless pipe connection (DIN 3862)
Materials	stainless steel AISI 303
Dimensions	min. 15 x 112 x 15 mm max. 17 x 110 x 17 mm min. 0.6 x 4.4 x 0.6 in max. 0.7 x 4.3 x 0.7 in
Mounting position	any

NOTE

Further technical information, technical drawings, accessories, spare parts or product function descriptions available on SKF.com/lubrication:

1276 EN



3D

skf-lubrication.partcommunity.com/3d-cad-models

Metering device

LG-doser

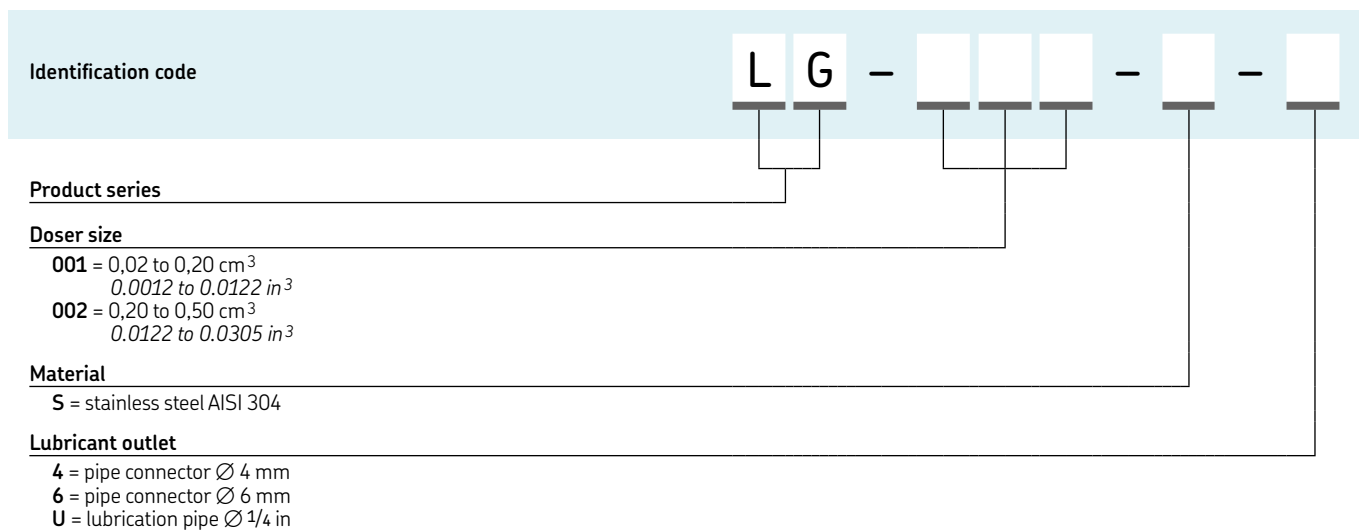

Accessory

Manifold



Description

For LG-doser metering devices, manifolds utilized are for 1 to 6 screw-in points with thread G 1/8 for O-ring sealing. Normal profile and opposite-side profile design manifolds are available in stainless steel AISI 303. Various designs of main line and feed line connections can be selected by order code.

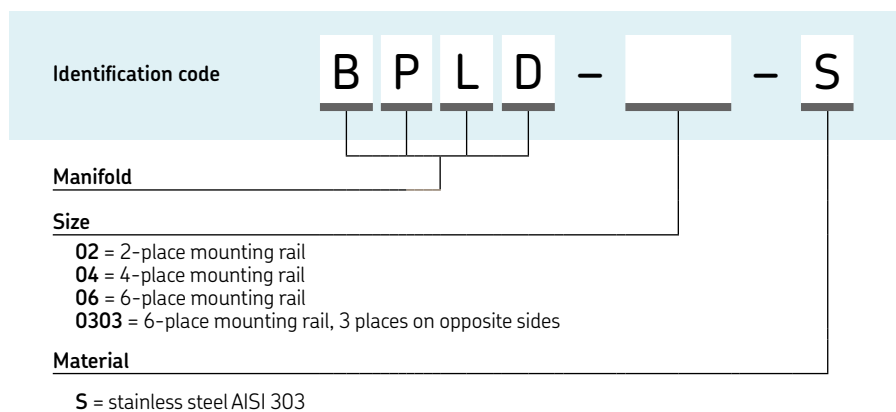

Metering device

SL-32HV



Description

The series SL-32HV (high venting) metering devices are for single-line, high-pressure centralized lubrication systems dispensing petroleum-based lubricants with a viscosity up to NLGI 2 (refer to Design Guide). Output is externally adjustable. The indicator stem permits visual check of metering device operation. Individual metering devices can be removed easily for inspection or replacement.

Features and benefits

- Shipped with manifolds from 1 to 10 ports to match number of lube points
- Output is externally adjustable
- Indicator stem permits visual check of operation
- Can be removed easily for inspection or replacement
- Available in stainless steel SAE 304

Applications

- Food and beverage, industrial automation
- Machine tools, oil and gas
- Steel industry, pulp and paper
- Marine and forestry, construction
- Wind energy, mobile on-road



NOTE

Further technical information, technical drawings, accessories, spare parts or product function descriptions available on SKF.com/lubrication.

Technical data

Function principle	metering device
Outlets	1 to 10
Metering quantity	0,016 to 0,131 cm ³ 0,001 to 0,008 in ³
Lubricant	grease NLGI 0, 1, 2
Operating temperature	max. +93 °C; +200 °F
Operating pressure	83 to 240 bar, 1 200 to 3 500 psi
Relief pressure	28 bar, 400 psi
Material	carbon steel, nitrile packings
Connection main line	1/4 NPTF (F), 1/4 NPTF (M)
Connection outlet	1/8 in O.D. tube
Lubricant point	solderless pipe connection (DIN 3862)
Dimensions	min. 44,5 × 93 × 52 mm max. 215 × 93 × 52 mm min. 1.8 × 3.6 × 2.1 in max. 8.5 × 3.6 × 2.1 in
Mounting position	any

Order information

Order number	Designation	Outlet
83336HV-1	metering device	1
83336HV-2	metering device	2
83336HV-3	metering device	3
83336HV-4	metering device	4
83336HV-5	metering device	5
83336HV-6	metering device	6
83336HV-7	metering device	7
83336HV-8	metering device	8
83336HV-9	metering device	9
83336HV-10	metering device	10
83338HV	metering device, single, no manifold	1
83337HV	metering device, single replacement	–

Metering device

SL-1



Description

The series SL-1 metering devices are for single-line, high-pressure centralized lubrication systems dispensing lubricants compatible with fluoroelastomer packings and viscosity up to NLGI 2. Output is externally adjustable. An indicator stem permits visual check of metering device operation. Individual metering devices can be removed easily for inspection or replacement. Available in stainless steel SAE 316, for applications where environmental conditions are hazardous to carbon steel or in industries preferring stainless steel.

Features and benefits

- Shipped with manifolds from 1 to 6 ports (lubrication points)
- Output is externally adjustable
- Each indicator stem permits visual check of injector operation
- Individual metering devices can be removed easily for inspection or replacement
- Includes fitting for feed lines via alternate outlet port
- Available in stainless steel SAE 316

Applications

- Mining and mineral processing
- Construction machinery, steel/heavy industry



NOTE

Further technical information, technical drawings, accessories, spare parts or product function descriptions available on SKF.com/lubrication.

Technical data

Function principle	metering device
Outlets	1 to 6
Metering quantity	0,131 to 1,31 cm ³ 0,008 to 0,080 in ³
Lubricant	grease NLGI 0, 1, 2
Operating temperature	-26 to +176 °C; -15 to +350 °F
Operating pressure	127 to 240 bar, 1 850 to 3 500 psi
Relief pressure	41 bar, 600 psi
Material	carbon steel, stainless steel 316
Connection main line	3/8 NPTF (F)
Connection outlet	1/8 NPTF (F)
Lubricant point	solderless pipe connection
Dimensions	min. 63 × 179,4 × 52,4 mm max. 203 × 179,4 × 52,4 mm min. 2.5 × 7.0 × 2.0 in max. 8.0 × 7.0 × 2.0 in
Mounting position	any

Order information

Order number	Designation	Outlet
81770-1	metering device	1
81770-2	metering device	2
81770-3	metering device	3
81770-4	metering device	4
81770-5	metering device	5
81770-6	metering device	6

Metering device

QSL



Description

QSL metering devices are designed for 300 bar pressure. As a result, NLGI 2 greases can be pumped at temperatures below zero without problems. All metering devices operate independently of each other. This means that in the event of a blockage or fault of one metering device, all other metering devices will continue to supply lubricant. A control pin on top shows proper function of each metering device.

Features and benefits

- Suitable for use with manifolds from 1 to 6 ports to match number of lube points; must be ordered separately
- Corrosion-resistant, black-chromated or nickel-plated surface
- Each indicator stem permits visual check of operation
- Can be removed easily for inspection or replacement
- Controlled via main line

Applications

- Renewable energy
- Construction machinery
- Mining and mineral processing
- Compact and medium-sized machines and industrial applications
- Commercial vehicles

Technical data

Function principle	metering device
Outlets	1 to 6
Metering quantity	0,05 to 0,4 cm ³ , 0.003 to 0.024 in ³
Lubricant	grease NLGI 0, 1, 2
Operating temperature	-40 to +70 °C; -40 to +158 °F
Operating pressure	140 to 300 bar, 2 030 to 4 350 psi
Relief pressure	≤ 60 bar, ≤ 870 psi
Materials	steel, black chromated, polyurethane
Connection main line	G 3/8 for steel pipe 16 × 2 mm; 0.63 × 0.08 in
Connection outlet	G 1/8 for tubes/hoses 4,1 × 2,3 mm; 0.16 × 0.09 in
Lubricant point	solderless pipe connection, DIN 3862 or SKF quick connector
Dimensions	length: max. 160 mm, 6.3 in Ø 28 mm; 1.1 in
Mounting position	any

NOTE

Further technical information, technical drawings, accessories, spare parts or product function descriptions available on SKF.com/lubrication:

12735 EN



3D

skf-lubrication.partcommunity.com/3d-cad-models

Metering device

QSL

QSL order numbers

Order number ¹⁾	Designation Injectors	Metering quantity per stroke		Ring color
		cm ³	in ³	
554-32810-1	QSL 0,05	0,05	0.00305	blue
554-32811-1	QSL 0,1	0,10	0.00610	white
554-32812-1	QSL 0,2	0,20	0.01220	yellow
554-32813-1	QSL 0,3	0,30	0.01830	red
554-32814-1	QSL 0,4	0,40	0.02440	green

¹⁾ In the case of backpressures in lubrication point lines of ≥ 100 bar or if several injectors are combined to one lubrication point, use check valves, order number 223-12289-7.

Accessory

Manifold, check valves and closure kit



Description

For QLS metering devices, manifolds utilized are for 1 to 6 push-in points tightened by a hollow screw with thread G 3/8 for O-ring sealing. Normal profile design manifolds are available in steel. The main line connection G 3/8 is for steel pipe 16 x 2 mm (0.63 x 0.08 in). The lubrication connection is for plastic tube 4,1 x 2,3 mm (0.16 x 0.09 in).

Manifolds¹⁾

Order number	Designation	Dimensions fixing hole		length, total	
		mm	in	mm	in
454-71505-1	divider bar, 2-fold	74	2.91	130	5.11
454-71506-1	divider bar, 3-fold	42	1.65	130	5.11
454-71507-1	divider bar, 4-fold	84	3.3	172	6.77
454-71508-1	divider bar, 5-fold	126	4.96	214	8.42
454-71509-1	divider bar, 6-fold	84 ¹⁾	3.3	256	10.07

¹⁾ Instead of the planned injectors a divider bar can also be equipped with a closure kit 5, order number: 554-34387-1

Check valves and closure kit

Order number	Designation
223-12289-7	check valves for connection at lubrication point outlets
554-34387-1	closure kit 5

Metering device

VR



Description

Product series VR are 1- to 12-port prelubrication metering devices for single-line, centralized lubrication systems for fluid grease and grease up to NLGI 2. These metering devices are characterized by an innovative, compact and sturdy design with SKF Quick Connector systems.

Features and benefits

- Innovative, extremely compact design
- Optional metering devices for 1 to 12 ports to match number of lubrication points
- Metering nipples with indicator pin for visual monitoring of each lubrication point
- Optional push-in type or screw-in type fittings for feed line or main line connections are selectable
- Easy metering adjustment by replacing the metering nipples
- Black anodized surface for optimized corrosion protection
- Suitable for corrosivity category C3 and C5 per DIN EN ISO 12944 and certified by Germanischer Lloyd
- High functional reliability when using stiff greases at low working temperatures

Applications

- Onshore and offshore wind energy systems
- Construction machinery
- Steel industry
- Heavy industry
- General mechanical engineering applications



Technical data

Function principle	block metering device
Outlets	1 to 12
Metering quantity	non-adjustable: 0,1 to 1,3 cm ³ /min 0.006 to 0.079 in ³ /min adjustable: 0,1 to 1,1 cm ³ /min 0.006 to 0.067 in ³ /min
Lubricant	fluid greases and grease NLGI 0, 1, 2
Operating temperature	-25 to +80 °C; -13 to +176 °F
Operating pressure	100 to 315 bar; 1 450 to 4 570 psi
Relief pressure	30 or 70 bar; 435 or 1 015 psi
Materials	anodized aluminum, stainless steel, FKM (FPM)
Connection main line	G 1/4 for pipes 4 or 6 mm 0.16 or 0.24 in
Connection outlet	G 1/8 for pipes 4 or 6 mm, 0.16 or 0.24 in
Lubricant point	solderless pipe connection (DIN 3862)
Dimensions	depending on model: min. 97 × 130 × 54 mm; max. 281 × 121 × 119 mm; min. 3.82 × 5.12 × 2.13 in max. 11.06 × 4.76 × 4.68 in
Mounting position	any

NOTE

Further technical information, technical drawings, accessories, spare parts or product function descriptions available on SKF.com/lubrication:

1-5001-EN, 951-230-007



3D

skf-lubrication.partcommunity.com/3d-cad-models

Metering device

VR

Identification code

V R

Product series

Number of metering points

01 = 1	07 = 7
02 = 2	08 = 8
03 = 3	09 = 9
04 = 4	10 = 10
05 = 5	11 = 11
06 = 6	12 = 12

Design for fluid grease and grease

Design code	A	B	C	D	E	F	G	H	N	P
Max. relief pressure [bar]	30	70	30	70	30	70	30	70	30	70
Secondary line connection	G 1/8	G 1/8	VS	VS	VS	VS	G 1/8	G 1/8	SRV ¹⁾	SRV ¹⁾
Secondary line Ø [mm]	–	–	4	4	6	6	–	–	6	6
Corrosivity category ²⁾	C3	C3	C3	C3	C3	C3	C5-M	C5-M	C5-M	C5-M

¹⁾ SRV = cutting-sleeve screw union, see page 2
²⁾ Corrosivity categories per DIN EN ISO 12944 (certified by Germanischer Lloyd)

Metering

Metering quantity letter	A ¹⁾	B ¹⁾	D ¹⁾	F ¹⁾	H ¹⁾	J ¹⁾	M ¹⁾	R ²⁾	X
Metering [cm ³]	0,1	0,2	0,4	0,6	0,8	1	1,3	0,1–1,1	Closed

¹⁾ Fixed metering with indicator pin for visual function monitoring
²⁾ Adjustable metering with indicator pin for visual function monitoring

Code letter

Metering quantity letter (0 = not present, e.g. for VR06 assign 0 for metering points 7–12)

Code for fittings for main line connection

Order example

VR06FFFFFFF000000Z

- Single-line distributor, 6-port
- Relief pressure max. 70 bar
- Lubrication point line connection using SKF plug connector for pipe Ø 6 mm
- Metering quantity 1–6 = 0,6 cm
- Without fitting for main line connection (G 1/4 thread)

Fittings for main line connection

Left fitting	Right fitting	Ø Main line [mm]	Code
Cutting-sleeve screw union *	Cutting-sleeve screw union *	8 10	A G
Cutting-sleeve screw union *	Closed	8 10	B H
Closed	Cutting-sleeve screw union	8 10	C J
E0-2 screw union	E0-2 screw union	8 10	D K
E0-2 screw union	Closed	8 10	E L
Closed	E0-2 screw union	8 10	F M
G1/4	G1/4	–	Z

Metering device

SLC



Description

The SKF Lincoln SLC metering device is designed for use in high-pressure singleline lubrication systems and features a modular design. Also, delivery volume can be adjusted via metering screws to ensure each lubrication point receives the required amount of lubricant. Featuring a spring-reset control piston, the metering device has a high venting capability compatible with greases up to NLGI 2. The SLC offers easy configuration to meet your needs, including different output quantity, fitting and adjustment options. With the most compact construction in its class, the SLC is suitable for many applications in renewable energy, construction, mining as well as in heavy industry.

Features and benefits

- High venting capability
- Wide delivery volume range
- Compact construction
- Easy to monitor and maintain
- Simplified failure analysis
- Reduced risk of leaks
- Reliable operation in harsh conditions with a wide operating temperature range
- Patented design and functionality
- Easy to clean

Applications

- Renewable energy
- Construction and mining
- Heavy industry



Technical data

Function principle	block metering device
Outlets	SLC1: 1 to 12 SLC2: 1 to 6
Metering quantity	optionally adjustable or fixed SLC1: 0.1–0.7 cm ³ /stroke; 0.006–0.042 in ³ /stroke SLC2: 0.2–1.4 cm ³ /stroke; 0.012–0.084 in ³ /stroke
Lubricant	grease up to NLGI 2
Operating temperature	–40 to +100 °C; –40 to +212 °F
Operating pressure	150 to 315 bar; 2 175 to 4 570 psi
Relief pressure	68 bar; 990 psi
Materials	steel
Corrosion protection class	C3-High, C4-Medium (DIN EN ISO 12944)
Dimensions	SLC1: min. 75 × 50 × 80 mm max. 215 × 50 × 180 mm min. 2.95 × 1.97 × 3.15 in max. 8.46 × 1.97 × 7.08 in SLC2: min. 75 × 40 × 80 mm max. 215 × 40 × 205 mm min. 2.95 × 1.57 × 3.15 in max. 8.46 × 1.57 × 8.07 in
Mounting position	any, preferably vertical



NOTE

Further technical information, technical drawings, accessories, spare parts or product function descriptions available on SKF.com/lubrication:

17717EN



3D

skf-lubrication.partcommunity.com/3d-cad-models

Metering device

SLC

Identification code S L C [] [] 3 - [] [] [] [] [] [] - [] [] []

Product series S L C

Doser size
 1 = SLC1 (1–2 outlets per section)
 2 = SLC2 (1 outlet per section)

Main line connections
 G = BSP thread for metric tubing
 A = NPTF thread for imperial tubing

Corrosion protection class
 3 = C3-H, C4-M

Layout variants
 A = Top: stroke adjustment
 B = Top: stroke adjustment, bottom: visual memory indicator
 C = Top: stroke adjustment, bottom: electrical performance detector
 D = Bottom: stroke adjustment
 E = Top: electrical performance detector, bottom: stroke adjustment

Metering quantity

<p>SLC1 single outlet/section version: 1 = 0,2 cm³/stroke; 0,012 in³/stroke 2 = 0,3 cm³/stroke; 0,018 in³/stroke 3 = 0,4 cm³/stroke; 0,024 in³/stroke 4 = 0,5 cm³/stroke; 0,030 in³/stroke 5 = 0,6 cm³/stroke; 0,036 in³/stroke 6 = 0,8 cm³/stroke; 0,048 in³/stroke 7 = 1,0 cm³/stroke; 0,060 in³/stroke 8 = 1,2 cm³/stroke; 0,072 in³/stroke 9 = 1,4 cm³/stroke; 0,084 in³/stroke S = adjustable 0,2–1,4 cm³/stroke; 0,012–0,084 in³/stroke V = reserve outlet, closed Z = adjustable, reserve outlet, closed X = no metering section</p>	<p>SLC1 twin outlet/section version: B = 0,1 cm³/stroke; 0,006 in³/stroke C = 0,15 cm³/stroke; 0,009 in³/stroke D = 0,2 cm³/stroke; 0,012 in³/stroke E = 0,25 cm³/stroke; 0,015 in³/stroke F = 0,3 cm³/stroke; 0,018 in³/stroke G = 0,4 cm³/stroke; 0,024 in³/stroke H = 0,5 cm³/stroke; 0,030 in³/stroke K = 0,6 cm³/stroke; 0,036 in³/stroke L = 0,7 cm³/stroke; 0,042 in³/stroke R = adjustable 0,1–0,7 cm³/stroke; 0,006–0,042 in³/stroke X = no metering section</p>	<p>SLC2 single outlet/section version: 1 = 0,2 cm³/stroke; 0,012 in³/stroke 2 = 0,3 cm³/stroke; 0,018 in³/stroke 3 = 0,4 cm³/stroke; 0,024 in³/stroke 4 = 0,5 cm³/stroke; 0,030 in³/stroke 5 = 0,6 cm³/stroke; 0,036 in³/stroke 6 = 0,8 cm³/stroke; 0,048 in³/stroke 7 = 1,0 cm³/stroke; 0,060 in³/stroke 8 = 1,2 cm³/stroke; 0,072 in³/stroke 9 = 1,4 cm³/stroke; 0,084 in³/stroke S = adjustable 0,2–1,4 cm³/stroke; 0,012–0,084 in³/stroke V = reserve outlet, closed Z = adjustable, reserve outlet, closed X = no metering section</p>
--------------------------------------------------------------------------------------------------------------------------------------------------------------------------------------------------------------------------------------------------------------------------------------------------------------------------------------------------------------------------------------------------------------------------------------------------------------------------------------------------------------------------------------------------------------------------------------------------------------------------------------------------------------------------------------------------------------------------------------------------------------------------------------------------------------------------------------------------------------------------------------------------------------------------------------------------------------------------------------------------------------------------------------------------------------------------------------	--------------------------------------------------------------------------------------------------------------------------------------------------------------------------------------------------------------------------------------------------------------------------------------------------------------------------------------------------------------------------------------------------------------------------------------------------------------------------------------------------------------------------------------------------------------------------------------------------------------------------------------------------------------------------------------------------------------------------------------------------------------------------------------------------------------------------------------------------------------------------------------------------------------------------------------------------------------------------	--------------------------------------------------------------------------------------------------------------------------------------------------------------------------------------------------------------------------------------------------------------------------------------------------------------------------------------------------------------------------------------------------------------------------------------------------------------------------------------------------------------------------------------------------------------------------------------------------------------------------------------------------------------------------------------------------------------------------------------------------------------------------------------------------------------------------------------------------------------------------------------------------------------------------------------------------------------------------------------------------------------------------------------------------------------------------------------

Lubricant inlet connections, main line

<p>X = no fitting A = Ø8 mm tube straight fitting, ferrule and nut B = Ø8 mm tube straight fitting, E02 seal C = Ø8 mm tube straight fitting without ferrule and nut D = Ø10 mm tube straight fitting, ferrule and nut E = Ø10 mm tube straight fitting, E02 seal F = Ø10 mm tube straight fitting without ferrule and nut G = Ø12 mm tube straight fitting, ferrule and nut H = Ø12 mm tube straight fitting, E02 seal I = Ø12 mm tube straight fitting without ferrule and nut K = Ø10 mm tube banjo fitting, ferrule and nut L = Ø10 mm tube banjo fitting without ferrule and nut M = Ø12 mm tube banjo fitting, ferrule and nut N = Ø12 mm tube banjo fitting without ferrule and nut</p>	<p>O = Ø8 mm tube adjustable elbow fitting, ferrule and nut P = Ø8 mm tube adjustable elbow fitting, E02 seal R = Ø8 mm tube adjustable elbow fitting without ferrule and nut S = Ø10 mm tube adjustable elbow fitting, ferrule and nut T = Ø10 mm tube adjustable elbow fitting, E02 seal U = Ø10 mm tube adjustable elbow fitting without ferrule and nut V = Ø12 mm tube adjustable elbow fitting, ferrule and nut W = Ø12 mm tube adjustable elbow fitting, E02 seal Y = Ø12 mm tube adjustable elbow fitting without ferrule and nut Z = closure plug</p>
---------------------------------------------------------------------------------------------------------------------------------------------------------------------------------------------------------------------------------------------------------------------------------------------------------------------------------------------------------------------------------------------------------------------------------------------------------------------------------------------------------------------------------------------------------------------------------------------------------------------------------------------------------------------------------------------------------------------------------------------------------------------------------------------------------------------------------------------------------------------------------------------------------------------------------------------------------------------------------	-------------------------------------------------------------------------------------------------------------------------------------------------------------------------------------------------------------------------------------------------------------------------------------------------------------------------------------------------------------------------------------------------------------------------------------------------------------------------------------------------------------------------------------------------------------------------------------------------------------------------------------------------------------------------------------------------------------------------------------------------------------

Lubricant outlet connections, feed line

<p>SLC1G: X = no fitting A = Ø6 mm tube plug in fitting R = Ø1/4 tube plug in fitting</p>	<p>SLC1A: X = no fitting R = Ø1/4 tube plug in fitting</p>	<p>SLC2G: X = no fitting A = Ø6 mm tube plug in fitting E = Ø8 mm tube plug in fitting I = Ø10 mm tube plug in fitting</p>	<p>SLC2A: X = no fitting</p>
-----------------------------------------------------------------------------------------------------------------------------------------------------------------	-------------------------------------------------------------------------------------------------------------	-----------------------------------------------------------------------------------------------------------------------------------------------------------------------------------------------------------------------	----------------------------------------------------------

Metering device

SL-11



Description

Series SL-11 metering devices are for single-line, high-pressure centralized lubrication systems dispensing lubricants compatible with fluoroelastomer packings and viscosity up to NLGI 2. Output is externally adjustable. An indicator stem permits visual check of metering device operation. Available only as single unit with 1/2 inch NPTF (F) inlet.

Features and benefits

- Output is externally adjustable
- Indicator stem permits visual check of injector operation
- May be combined in a circuit of metering devices SL-32, SL-33, SL-VXL, SL-V and/or SL-1
- Can be removed easily for inspection or replacement
- Includes fitting for filling feed lines via alternate outlet port
- Available in stainless steel SAE 316

Applications

- Construction machinery
- Mining and mineral processing
- Steel industry
- Heavy industry

Technical data

Order number	85497
Function principle	metering device
Outlets	1
Metering quantity	0,82 to 8,2 cm ³ 0,050 to 0,500 in ³
Lubricant	grease NLGI 0, 1, 2
Operating temperature	-40 to +93 °C; -40 to +200 °F
Operating pressure	70 to 240 bar, 1 000 to 3 500 psi
Relief pressure	55 bar, 800 psi
Materials	carbon steel, FKM, PTFE
Connection main line	1/2 NPTF (F)
Connection outlet	1/4 NPTF (F)
Lubricant point	solderless pipe connection (DIN 3862) or plug connector
Dimensions	73 × 241 mm 2,87 × 9,48 in
Mounting position	any

Metering devices have fluoroelastomer packings. Check packing compatibility with synthetic lubricants; metering devices supplied with fitting for filling feed line via alternate outlet port. Output with adjustment screw hand-tightened is 0,82 cm³ (0,05 in³); maximum output is achieved with 11 1/2 turns at 0,66 cm³/turn (0,04 in³/turn).

NOTE

Further technical information, technical drawings, accessories, spare parts or product function descriptions available on SKF.com/lubrication.

Metering device

SL-V

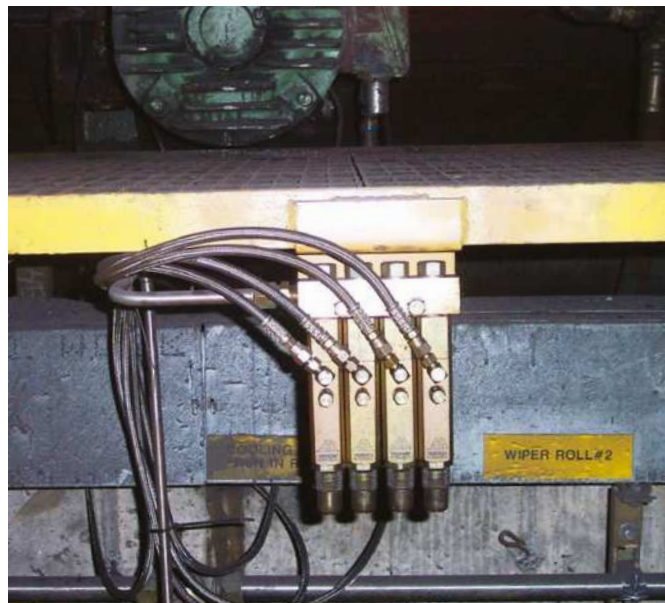

Description

Series SL-V metering devices are for single-line, high-pressure centralized lubrication systems dispensing lubricants compatible with polyurethane seals up to NLGI 2. Output is externally adjustable. An indicator stem permits visual check of metering device operation. Individual metering devices can be removed easily for inspection or replacement. Each SL-V metering device includes a clear, polycarbonate protective cap.

Features and benefits

- Shipped with manifolds from 1 to 6 ports
- Output is externally adjustable
- Clear, polycarbonate protected cap over indicator stem permits visual check of operation
- Can be removed easily for inspection or replacement
- Available in carbon steel or stainless steel SAE 304
- Output setting system by a set of color-coded sleeves

Applications

- Construction machinery
- Mining and mineral processing
- Steel industry



NOTE

Further technical information, technical drawings, accessories, spare parts or product function descriptions available on SKF.com/lubrication.

Technical data

Function principle	metering device
Outlets	1 to 6
Metering quantity	0,25 to 1,31 cm ³ 0.015 to 0.08 in ³
Lubricant	grease NLGI 0, 1, 2
Operating temperature	max. +82 °C; +180 °F
Operating pressure	128 to 413 bar, 1 850 to 6 000 psi typical: 172 bar, 2 500 psi
Relief pressure	70 bar, 1 000 psi
Materials	carbon steel
Connection main line	3/8 NPTF (F)
Connection outlet	1/8 NPTF (F)
Dimensions	min. 63 × 222 × 35 mm max. 203 × 222 × 35 mm min. 2.5 × 8.7 × 1.4 in max. 6.1 × 8.7 × 1.4 in
Mounting position	any

Metering device manifolds have 10,3 mm (0.4 in) dia. mounting holes for 9,5 mm (0.375 in) bolt; metering devices have polyurethane seals; check compatibility with synthetic lubricants; metering devices include fitting for filling feedlines via alternate outlet port; output with adjustment screw hand-tightened is 0,246 cm³ (0.015 in³); maximum output is achieved with five turns at 0,229 cm³/turn (0.014 in³/turn).

Order information

Order number	Outlets	Designation
85770-1	1	Metering device incl. manifold
85770-2	2	Metering device incl. manifold
85770-3	3	Metering device incl. manifold
85770-4	4	Metering device incl. manifold
85770-5	5	Metering device incl. manifold
85770-6	6	Metering device incl. manifold
85771	1	Replacement metering device for manifold
85772	1	Single metering device, no manifold inlet 3/8 NPTF (M)

Metering device

SL-V XL



Description

Series SL-VXL high-output metering devices are for single-line, high-pressure centralized lubrication systems dispensing lubricants compatible with polyurethane seals up to NLGI 2. Output is externally adjustable. An indicator stem permits visual check of metering device operation. Individual metering devices can be removed easily for inspection or replacement. Two SL-VXL metering devices are required to replace one SL-11 metering device. Each SL-VXL metering device includes a clear, polycarbonate protective cap.

Features and benefits

- Suitable for use with manifolds from 1 to 6 ports to match number of lubrication points
- Output is externally adjustable
- Includes a clear, polycarbonate protective cap over indicator stem that permits visual check of operation
- Can be removed easily for inspection or replacement
- Includes fitting for filling feed lines via alternate outlet port
- Available in carbon steel or stainless steel SAE 304

Applications

- Construction machinery
- Mining and mineral processing
- Heavy industry

Technical data

Function principle	metering device
Outlets	1 to 6
Metering quantity	0,25 to 5,00 cm ³ , 0.015 to 0.305 in ³
Lubricant	grease NLGI 0, 1, 2
Operating temperature	-40 to +82 °C; -40 to +180 °F
Operating pressure	128 to 413 bar; 1 850 to 6 000 psi
Relief pressure	70 bar; 1 000 psi
Materials	carbon steel
Connection main line	3/8 NPTF (F)
Connection outlet	1/8 NPTF (F)
Lubricant point	solderless pipe connection (DIN 3862) or plug connector
Dimensions	min. 63 × 284 × 35 mm max. 203 × 284 × 35 mm min. 2.5 × 11.2 × 1.4 in max. 6.1 × 11.2 × 1.4 in
Mounting position	any

Metering device manifolds have 10,3 mm (0,4 in) dia. mounting holes for 9,5 mm (0,375 in) bolt; metering devices have polyurethane seals. Check compatibility with synthetic lubricants; metering devices include fitting for filling feed lines via alternate outlet port; output with adjustment screw hand-tightened is 0,246 cm³ (0,015 in³); maximum output is achieved with 20,5 turns at 0,229 cm³/turn (0,014 in³/turn).

NOTE

Further technical information, technical drawings, accessories, spare parts or product function descriptions available on SKF.com/lubrication.

Metering device

SL-V XL

Identification code

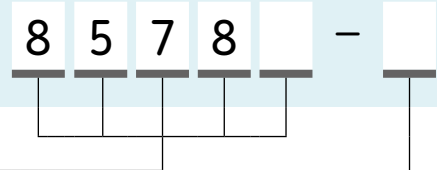

Product series, carbon steel

- 85780 = metering device incl. manifold, 3/8 NPTF (M) inlet
- 85781 = replacement for manifold metering device (only one outlet possible)
- 85782 = single metering device, no manifold, 3/8 NPTF (M) inlet (only one outlet possible)

Outlets

- 1 = 1
- 2 = 2
- 3 = 3
- 4 = 4
- 5 = 5
- 6 = 6



Overview of control units

Control units							
Product	Operating temperature		Supply voltage max.		Adjustable	Level monitoring	Page
	°C	°F	VDC	VAC			
EXZT2A02	0 to 60	+32 to 140	12/24	120	•	–	152
EXZT2A05	0 to 60	+32 to 140	12/24	120	•	•	152
EXZT2A07	0 to 60	+32 to 140	12/24	120	•	•	152
IGZ36-20	0 to 60	+32 to 140	12/24	120	•	–	152
IGZ36-20-S6	0 to 60	+32 to 140	12/24	120	•	•	152
IGZ38-30	0 to 60	+32 to 140	12/24	120	–	•	152
IGZ38-30-S1	0 to 60	+32 to 140	12/24	120	–	•	152
IGZ51-20-S3	0 to 60	+32 to 140	12/24	120	–	–	152
IG502-2-E	-25 to +75	-13 to +167	12/24	–	•	•	154
LC502	0 to 60	+32 to 140	12/24	–	•	•	155
ST-2240-LUB	0 to 50	+32 to 140	–	132/264	•	•	156
ST-1240	0 to 50	+32 to 140	–	132/264	•	•	157
ST-1100i	-20 to +60	-4 to +142	–	93-264	•	•	158
ST-102	-40 to +80	-40 to +176	12/24	–	•	•	159
ST-102P	-40 to +80	-40 to +176	12/24	–	•	•	160
84501	-18 to +54	0 to +130	–	120/230	•	–	161
LMC 101	-40 to +65	-40 to +150	12/24	–	•	•	162
EOT-1	-25 to +70	-13 to +158	12/24	–	•	•	163
EOT-2	-25 to +70	-13 to +158	12/24	–	•	•	163
85307	-15 to +50	+5 to 122	12/24	–	•	•	164
LMC 2	-10 to +70	+14 to 158	12/24	230	•	•	165
LMC 301	-40 to +70	-40 to +158	24	90-264	•	•	166

Control unit

EXZT/IGZ



Description

Universal electronic control and monitoring devices are used in single-line and progressive lubrication systems for stationary industrial applications, installed in a switching cabinet or internally in a compact lubrication unit. Two different versions are required: +471 for 100 to 120 VAC and 200 to 240 VAC; and +472 for 24 VDC and 24 VAC. The universal devices can be used as time-dependent or pulse-dependent controllers. The main task is to initiate a lubrication cycle after a set time. The devices also monitor the piston strokes and run the pump during the lubrication time in clogged operation. All devices have custom-built functions integrated and can be configured to meet the requirements of the application. Mentioned device models must be selected based on their special function configuration and additional features according to the user manual.

Features and benefits

- Easy installation via top hat rail mounting
- One unit for different operating modes such as timer, counter and monitoring functions; other features are adjustable
- Pulse generator/counter with adjustable interval time
- Time operation or machine clogged operation
- Pump run time limitation
- Monitoring of pressure build-up, contact (NO)
- Low-level control and EEPROM as an additional feature

Applications

- All single-line lubrication systems for stationary industrial applications

Technical data

Function principle	universal electronic control and monitoring device
Operating temperature	0 to 60 °C; +32 to 140 °F
Output voltage	24 VDC +10% / -15%
Connector for class	II
Protection class	IP 30, clamps IP 20
Dimensions	70 × 75 × 110 mm 2.7 × 3 × 4.3 in

Version + 471

Input voltage	100 – 120 VAC; 200 – 240 VAC
Input current rated	70 mA / 35 mA
Power input	8 W
Frequency	50 – 60 Hz
Fuse	max. 6.3 A
Switching current	max. 5 A
Input voltage sensors	24 VDC

Version + 472

Input voltage	20 to 24 VDC; 20 to 24 VAC
Input current rated	75 mA at max. fan-out of 250 mA
Power input	5 W
Frequency	DC or 50 – 60 Hz
Fuse	max. 6.3 A
Switching current	max. 5 A
Input voltage sensors	24 VDC



NOTE

Further technical information, technical drawings, accessories, spare parts or product function descriptions available on SKF.com/lubrication:

1-1700-4-EN, 951-180-001

Control unit

EXZT/IGZ

Order information

Order number	Input voltage	Adjustable monitoring time	Adjustable pump delay time	Monitoring of pressure relief, contact	Lubricant level monitoring, contact	Interval time extension	Early lubricant level warning, contact	Pulse monitoring	Adjustable failure memor EEPROM
EXZT2A02+471	120 VAC	•	•	NO ¹⁾	NO ¹⁾	•	–	–	–
EXZT2A02+472	24 VDC	•	•	NO ¹⁾	NO ¹⁾	•	–	–	–
EXZT2A05+471	120 VAC	•	•	–	NC ²⁾	•	–	•	–
EXZT2A05+472	24 VDC	•	•	–	NC ²⁾	•	–	•	–
EXZT2A07+471	120 VAC	•	•	–	NC ²⁾	•	•	–	–
EXZT2A07+472	24 VDC	•	•	–	NC ²⁾	•	•	–	–
IGZ36-20+471	120 VAC	•	•	NC ²⁾	NO ¹⁾	–	–	–	–
IGZ36-20+472	24 VDC	•	•	NC ²⁾	NO ¹⁾	–	–	–	–
IGZ36-20-S6+471	120 VAC	•	•	NC ²⁾	NC ²⁾	–	–	–	–
IGZ36-20-S6+472	24 VDC	•	•	NC ²⁾	NC ²⁾	–	–	–	–
IGZ38-30+471	120 VAC	–	–	–	NC ²⁾	–	–	–	–
IGZ38-30+472	24 VDC	–	–	–	NC ²⁾	–	–	–	–
IGZ38-30-S1+471	120 VAC	–	–	–	NO ¹⁾	–	–	–	–
IGZ38-30-S1+472	24 VDC	–	–	–	NO ¹⁾	–	–	–	–
IGZ51-20-S3+471	120 VAC	•	•	NC ²⁾	NO ¹⁾	•	–	–	•
IGZ51-20-S3+472	24 VDC	•	•	NC ²⁾	NO ¹⁾	•	–	–	•

1) NO = contact normally open
2) NC = contact normally closed

Control unit

IG502-2-E



Description

The IG 502-2-E is a universal control and monitoring device for centralized lubrication in single-line and progressive lubrication systems. The compact device is equipped with a display panel for parameter settings and function monitoring. Different operating modes such as timer, counter and monitoring functions for pressure and cycle switches are programmable in their individual functions. The display panel is protected against moisture and dirt. A red LED shows faults as a collective message. Two integrated electronic counters are used for permanent operation control and failed hours, where pump could not operate properly. In both counters, saved times cannot be deleted. The working-hour meter summarizes times when supply voltage at the device is switched on. The device has its own database independent of supply voltage for saving configuration and parameters. To avoid environmental influences, it is advisable to install the device inside of a cabin.

Features and benefits

- Universal control and monitoring device
- Compact design
- Easy to handle operations
- Different operating modes such as timer, counter and monitoring functions
- Red LED for failure indication and cause
- Integrated counters for permanent operation, failed hours and working-hour meter show complete life cycle of system

Applications

- Commercial vehicles
- Construction machinery
- Agriculture

Technical data

Function principle	control unit
Control voltage	max. 12 or 24 VDC
Contact load connector M	5 A at 12 or 24 VDC
SL-output	4 W
Protection class	IP 20 DIN 40050, plug IP 00
Temperature range	-25 to +75 °C; -13 to +167 °F
Storage temperature	-40 to +75 °C; -40 to +167 °F
Fuse protection	max. 5 A
Adjustable pause time	0,1 h to 99,9 h
Adjustable pump running time	0,1 min to 99,9 min
Adjustable pulse time	1 to 999
Operation hours storage	0 to 99999,9 h
Operation- failed hours storage	0 to 99999,9 h
Dimensions	138 × 65 × 40 mm 5.43 × 2.56 × 1.57 in

Order information

Order number	Description
IG 502-2-E+912	Controller 12 V DC
IG 502-2-E+924	Controller 24 V DC
997-000-185	Wire set

NOTE

Further technical information, technical drawings, accessories, spare parts or product function descriptions available on SKF.com/lubrication:

951-180-002 EN

Control unit

LC502



Description

The compact LC502 is an all-purpose controller suitable for single-line, progressive and dual-line systems. Supplied as a separate unit or already integrated in the pump, this versatile controller includes a basic power switch, motor circuit breaker (230/400 VAC types) start button and fault indicator light. The unit's user-friendly display enables input of customer-specific settings in up to seven languages (optional). Integration of the LC502, configuration of technical ratings and characteristics depend on the customer's specific application.

Features and benefits

- Easy-to-operate, programmable controller
- System monitoring and error detection/failure remedy
- Integrated temperature-overload safety device
- Up to three lubrication circuits can be controlled or monitored separately

Applications

- Special-purpose machinery and general industry
- Cement and steel plants
- Food and beverage

Technical data

Function principle	control unit
Operating temperature	0 to +60 °C; +32 to 140 °F
Operating voltage	
24 VDC	0,16 ... 0,25 kW
230 VAC and 400 VAC 3-phase	0,15 ... 0,85 kW
Operating voltage frequency	50 to 60 Hz
Electrical connectors	4
Electrical output connectors	4
Input voltage	12 or 24 VDC
Protection class	IP 54
Off time (cycle)	8 h
On time (pumping)	1 h
Fuses	
F1: 400 VAC and 203 VAC	5 × 20 mm / 4 A
F2: 400 VAC, 230 VAC 24 VDC	5 × 20 mm / 2 A
Cycle settings dependent on	time, machine pulse pump revolutions
Possible low-level controls: W1	wipe /dynamic
Possible low-level controls: W2	wipe /capacitive / static
Lubrication circuits	analog
Rotation	max. 2
	10 (for industry and vehicle pumps)
	corresponds to 10 agitator rotations
Dimensions, for control cubicle	400 × 400 × 600 mm
	15.75 × 15.75 × 23.62 in
Mounting position	vertical, cable terminals pointing downwards

Order information

Order number	Designation
24-1074-2270	LC 502; 24 V DC; 0,25 kW; for single-line systems
24-1074-2240	LC 502; 230 VAC; 0,85 kW; for single-line systems
24-1074-2210	LC 502; 400 VAC; 0,85 kW; for single-line systems



NOTE

Further technical information, technical drawings, accessories, spare parts or product function descriptions available on SKF.com/lubrication:

950-180-004-EN

Control unit

ST-2240-LUB



Description

ST-2240-LUB-6 and ST-2240-LUB-14 lubrication control centers are suitable for use in dual-line lubrication systems, as well as single-line and progressive systems. These units have a touchscreen display and are only differentiated by the cabinet size and maximum number of lubrication channels served. The ST-2240-LUB-6 controls up to 6 separate lubrication channels, while ST-2240-LUB-14 controls up to 14 channels, each having independent lubrication parameters and/allows use of different lubricants if required. The lubrication system is adjustable at field site by adding or reducing channel modules, and configuration can be changed in the field by the user. Pressure switches and transmitters or piston detectors can be used in all channels. Also the new lubricant low level ultrasonic sensor is supported.

Features and benefits

- Versatile and durable, automatic pump change (Dualset)
- Modular units provide easy system modification
- Compatible with ultrasonic low level sensor
- Grease spraying control with air monitoring
- Compatible with SKF doser monitor

Technical data

Function principle	control center
Operating temperature	0 to +50 °C, +32 to +122 °F
Lubricant channels	1-14
Supply voltage	115/230 V AC, automatic range selection
Supply voltage frequency	47 to 63 Hz
Control voltage	24 V DC, ± 10 %
Overload protection	automatic fuse, 6 A
Cable connection	screw terminals for 2,5 mm ² wires
Protection class	IP 65
Interface	5.7" TFT touch screen , 320 × 240, 64k colors, ethernet and USB port mobile app for monitoring
Data logging	Log files on USB memory
Fieldbus	ModbusTCP slave, other protocols on request
Alarm Outputs	relays K1 & K2: potential-free change over contact; maximum load 230 V/1 A; channel modules: potential-free contact; maximum load 50 V DC/1 A
Dimensions	600 × 600 × 250 mm 23.6 × 23.6 × 9.8 in

Order information

Order number	Designation
12380760	ST-2240-LUB-6 control center
12380765	ST-2240-LUB-14 control center
12501270	CM channel module



NOTE

Further technical information, technical drawings, accessories, spare parts or product function descriptions available on SKF.com/lubrication:
PUB LS/P2 17950 EN

Control unit

ST-1240



Description

The ST-1240 is a two-channel lubrication control centre that supports any combination of single-line, dual-line and progressive lubrication systems. The lubrication channels can be zones, separated by shut-off valves, or complete lubrication systems with separate pumping centres and varying lubricants. Configuration can be set in the field by touchscreen display.

Features and benefits

- Automatic pump change (Dualset)
- Grease spraying control with air monitoring
- IP 65 protection rating
- Compatible with SKF doser monitor
- Works with SKF online control software

Technical data

Function principle	control center
Operating temperature	0 to +50 °C, +32 to +122 °F
Lubrication channels	2
Supply voltage	93 to 132 V AC, 186 to 264 V AC
Supply voltage frequency	47 to 63 Hz
Supply current	5,4 A/115 V AC, 2,2 A/230 V AC
Control voltage	24 V DC, ± 10%
Overload protection	automatic fuse, 6 A
Cable connection	screw connections for 2,5 mm ² wires
Protection class	IP 65
Interface	touchscreen display RS-422 port for SKF online software
Dimensions (without cable glands)	380 × 300 × 210 mm 14.9 × 11.8 × 8.3 in

Order information

Order number	Designation
12380210	ST-1240 GRAPH control centre
12380220	ST-1240-IF control centre
12380747	SMS control and monitoring module for ST-1240-IF control centre



NOTE

Further technical information, technical drawings, accessories, spare parts or product function descriptions available on SKF.com/lubrication:

PUB LS/P8 12404/1 EN

PUB LS/P2 18265 EN

Control unit

ST-1100i



Description

SKF ST-1100i is an one-channel, microprocessor-based control centre for single-line, dual-line and progressive lubrication systems. All lubrication configurations can be set in the field by user interface. The centre controls lubrication according to the desired settings, and lubrication events can be monitored. Lubrication programming, alarm acknowledgements and lubrication event monitoring can be performed via both the control panel and the LED signals. The control panel is located inside the casing. The user interface is a three-button, six-digit display and can be used for setting the default values for the lubrication program and for turning on manual control.

Features and benefits

- Simple monitoring via control panel and cover LED signals
- All lubrication configurations can be set in field by user interface
- Set values and program status at the power failure are stored in an EEPROM-memory; no battery

Applications

- Construction machinery, mining applications

Technical data

Function principle	control unit
Operating temperature	-20 to +60 °C; -4 to +142 °F
Lubricant	oil and grease
Lubricant channels	1
Operating voltage	93 to 132 VAC, 186 to 264 VAC
Operating voltage frequency	50/60 Hz
Control voltage	24 VDC, ± 10%
Protection class	IP 65
Interface	6-digit, 3-button user interface
Lubrication cycle	0 min 00 s to 9 999 min
Pressurization	0 min 00 s to 999 min
Dimensions	200 × 300 × 120 mm 8.66 × 11.8 × 4.7 in
Mounting position	vertical

Order information

Order number ¹⁾	Designation
12380600	ST-1100i-ENG (menu: english language version)
12380692	ST-1100i-SS-ENG (menu: english language version) stainless steel enclosure

¹⁾ Further product versions available on request.



NOTE

Further technical information, technical drawings, accessories, spare parts or product function descriptions available on SKF.com/lubrication:

13165 EN

Control unit

ST-102



Description

The ST-102 controller is designed for the control and monitoring of single-line, dual-line and progressive lubrication systems in vehicles with a 12 or 24 VDC power supply. It is a one-channel lubrication control centre for systems with pneumatic or electrical pumps. The ST-102 is suitable for environments with temperatures ranging from -30 to +80 °C (-22 to +176 °F) and features an IP 30 protection class. All lubrication configurations can be set in the field by the user.

Features and benefits

- Available for 12 or 24VDC
- Suitable for operational environments with extreme temperatures
- One-button user interface
- Power failure memory

Applications

- Service vehicles
- Construction machinery
- Agriculture machinery

Technical data

Order number	11500610
Function principle	control and monitoring device
Operating temperature	-30 to +80 °C; -22 to +176 °F
Power supply	12 and 24 VDC; (10,5 to 32 VDC)
Pump output control	max. 5 A
Protection class	IP 30
Self-setting fuse	4 A on pcb
Time, cycle settings:	
Max. pressurization time	1 to 20 min
Interval time	5, 10...120 min
Pressurization time	1, 2, 3...10 min
Interface	1-button user interface, 3 LED's
Input	4 digital
Output	4 digital
Standard	CE
Dimensions	26 × 60 × 160 mm 1.02 × 2.36 × 6.3 in
Mounting position	vertical



NOTE

Further technical information, technical drawings, accessories, spare parts or product function descriptions available on SKF.com/lubrication:

6408 EN

Control unit

ST-102P



Description

The ST-102P one-channel lubrication control centre is designed for the control and monitoring of lubrication systems in 12VDC or 24VDC vehicles. It supports single-line and dual-line lubrication systems. All lubrication configurations can be set in the field by the user. The ST-102P casing has an IP 65 rating.

Features and benefits

- Designed for control and monitoring in 12/24 VDC lubrication systems
- Reliable and durable, one-channel lubrication controller
- Supports single-line and dual-line lubrication systems
- All lubrication configurations can be set in the field by user
- IP 65 rating

Applications

- Control of lubrication systems with pneumatic pump SKF 4OPGAS and electrical pump SKF Minilube
- Small excavators
- Wheel loaders,
- Trucks and buses

Technical data

Order number	11500608
Function principle	control unit
Operating temperature	-40 to +80 °C -40 to +176 °F
Operating voltage	12 or 24 VDC (10,5 to 32 VDC)
Pump output control	max. 5 A
Protection class	IP 65
Self-setting fuse	4 A on printed circuit board
Time, cycle settings:	
Pressurization time	1 to 20 min
Interval time	5, 10...120 min
Interface	1-button user interface, 3 LEDs
Dimensions	67 × 80 × 170 mm 2.64 × 3.14 × 6.7 in
Mounting position	vertical



NOTE

Further technical information, technical drawings, accessories, spare parts or product function descriptions available on SKF.com/lubrication:

13165 EN

Control unit

84501



Description

Model 84501 program timer is used to control the lubrication cycle frequency of air-operated, single-stroke pumps. The timer turns pump on/off at programmed intervals via a 3-way or 4-way air solenoid valve (not included) installed in the air line to the pump. It is capable of retaining memory for three hours during machine shut down or power failure. Timing is suspended during power interruptions. This feature eliminates over-lubrication due to pre-lube when machine is frequently started and stopped. Using two programmable jumper pins, four options are available with the memory and prelube feature.

Features and benefits

- Program timer controls lubrication cycle frequency of air-operated, single-stroke pumps
- Timer turns pump on/off via solenoid air valves in programmed intervals
- Retains memory for three hours during machine shut down or power interruption
- Suspended timing during power interruptions eliminates over-lubrication due to pre-lube when machine is frequently started and stopped

Applications

- Cement industry
- Food and beverage
- Assembly lines
- Conveyors



Technical data

Order number	84501
Function principle	control unit
Operating temperature	-18 to +54 °C; 0 to +130 °F
Operating voltage	120/230 VAC
Operating voltage frequency	50/60 Hz
Switch capacity	120 VAC: 5 A 230 VAC: 1,5 A
Off-time cycle	min. 20 sec; max. 24 h
Off-time pumping	min. 10 sec; max. 1 min 24 sec
Prelube on time	40 sec
Protection class	NEMA 1
Standards	UL, CSA
Dimensions	173 × 210 × 125 mm 7 × 8 × 5 in
Mounting position	vertical



NOTE

Further technical information, technical drawings, accessories, spare parts or product function descriptions available on SKF.com/lubrication.

Control unit

LMC 101



Description

LMC 101 is a universal control and monitoring device for single-line and progressive lubrication systems. In single-line systems, pressure switches or pressure transducers can be installed at the pump and/or end of the supply line. While designed for off-the-road and mobile equipment use, the controller can be used for any low-voltage lubrication application. Timer or controller mode can be set for both systems. The device features various alarm condition settings, including cycle frequency or alarm triggers. Programming, data logging and reporting are possible, including system resets, downloads to controllers, lubrication activity, lubrication cycles and alarms. The controller must be programmed via USB connection to PC. In timer mode, the lubrication cycle ends when pre-assigned time has expired. In controller mode, the lubrication cycle ends when pressure switch, pressure transducer or piston detector actuates. System allows pressure to dissipate to end of supply line once pressure at pump is reached.

Features and benefits

- Various alarm condition settings including cycle frequency and alarm triggers
- Programming, data logging and reporting, including system resets, downloads to controllers, lubrication activity, lubrication cycles and alarms
- Display: LEDs, pump on and system fault (alarm)
- Controller must be programmed via USB connection to PC
- Manual lubrication push-button

Applications

- Off-highway vehicles
- Mobile equipment use

Technical data

Order number	86535
Function principle	control unit
Voltage input	12 VDC and 24 VDC -20%/ +30%
Current consumption	60 mA (less external load)
Vent relay contact	20 A at 30 VDC
Pump relay contact	2 A at 30 VDC
Alarm relay contact	2 A at 30 VDC
Enclosure rating	NEMA 12
Operating temperature	-40 to +65 °C; -40 to +150 °F
Net weight	0,9 kg, 2 lbs
Off-time adjustable	15 sec to 99 h
On-time adjustable	15 sec to 99 h
Lubrication systems	single-line and progressive systems
Enclosure size	209 × 127 × 89 mm 8.25 × 5 × 3.50 in
Mounting dimensions	222 × 95 mm 8.75 × 3.75 in

 **NOTE**

Further technical information, technical drawings, accessories, spare parts or product function descriptions available on SKF.com/lubrication:

15625 EN



3D

skf-lubrication.partcommunity.com/3d-cad-models

Control unit

EOT-1/2 664-34135-6, 664-34135-7



Description

EOT-1 / EOT-2 are time controllers for lubrication pumps in single-line or progressive lubrication systems. EOT-1 has a fixed running time of 4 seconds and flexible pause time adjustments and, therefore, is suitable for chain lubrication. EOT-2 features flexible time settings. Both controllers are required if pumps without timers are used in lubrication systems or there is no customer-related request for pumps with an integrated pump controller. It also is suitable for retrofit installation. Simply set time using the red (running time) and a blue (pause time) switches and use the push-button to activate an additional lubrication cycle for easy and safe pump operation.

Features and benefits

- Time controller for installation in driver's cabin
- Suitable for retrofit
- Simple handling of time setting and function control

Applications

- Agriculture
- Chain lubrication systems

Technical data

Function principle	control unit
Supply voltage	12/24 V DC
Max. current draw	≤ 7 A
Protection class	IP 65 , SELV/PELV
Operating temperature	-25 to +70 °C; -13 to +158 °F
Noise suppression	class AVDE 0875 T11
Interference resistance	DIN EN 61000-6-1
Transient emissions	DIN EN 61000-6-3
Outputs	transistor/ no
EEPROM	non-dissipative storage of data

EOT 1	
Pause time	min. 5 sec, max. 75 min
Running time	4 sec, unvaried

EOT 2	
Pause time	min. 4 min, max. 15 h
Running time	min. 8 sec, max. 30 min

Factory setting	
EOT 1	
Pause time	15 sec
Running time	4 sec

EOT 2	
Pause time	6 min
Running time	4 sec

Dimensions	122 × 118 × 56 mm 4.8 × 4.6 × 2.2 in
------------	-----------------------------------------

Mounting position	any
-------------------	-----

Order information

Order number	Designation
664-34135-6	EOT 1 controller for SKF Lincoln EOP pumps
664-34135-7	EOT 2 controller for one pump unit (not EOP)

NOTE Further technical information, technical drawings, accessories, spare parts or product function descriptions available on SKF.com/lubrication:
951-181-005 EN

3D
skf-lubrication.partcommunity.com/3d-cad-models

Control unit

85307



Description

The SKF 85307 lubrication controller provides confidence that machinery is receiving proper lubrication. Equipped with both visual and audible fault notifications, the unit's three-digit LED displays easy-to-identify codes so that lubrication system issues can be addressed quickly and efficiently. Compatible with single-line, dual-line and progressive lubrication systems, the lubrication controller has a durable, compact housing with a small footprint. Also, it is simple to install because the wiring harness attaches directly into the controller.

Optional data shuttle 85307-DS collects log files from 85307 controllers on site for later download to a PC for analysis. Up to 256 files are stored by serial number. 85307-DS also features lock/unlock 85307 controller configuration.

Features and benefits

- Easy-to-identify error codes
- Visual and audible fault notification
- Small footprint; fits in any vehicle cab
- Simple to install
- Monitors reservoir level
- Counts lubrication cycles
- Operating temperature range of -15 to $+50$ °C (5 to 122 °F)
- 12-volt or 24-volt operation
- Timing intervals from five seconds to 24 hours

Applications

- Off-road and mobile construction equipment
- General industry applications
- Chain lubrication systems
- Agriculture machinery

Technical data

Order number	85307
Function principle	electronic control unit with datalogger capabilities
Operating temperature	-15 to $+50$ °C; $+5$ to $+122$ °F
Connection input	wiring harness - 14 way MOLEX MINIFIT - JR
Output	4-pin connector to DataShuttle
Supply voltage	12 or 24 VDC
Protection class	IP 54
Dimensions	70 x 145 x 38 mm 2.8 x 5.7 x 1.5 in
Mounting position	any

Accessories

Order number	Description
279630	Wiring harness
85307-DS	Data shuttle



NOTE

Further technical information, technical drawings, accessories, spare parts or product function descriptions available on SKF.com/lubrication:

17963 EN, Form 404766 v2

Control unit

LMC 2



Description

The LMC 2 is a controller for the electronic management and monitoring of lubrication systems. It combines the advantages of a specially developed printed circuit board (PCB) and a PLC in an economical, compact unit.

Features and benefits

- Integrated, flexible lubrication programs
- 8 inputs / 5 outputs; suitable for complex lubrication systems
- Time- or cycle-dependent control of lubrication intervals
- Can be interfaced with common field bus systems

Applications

- Lincoln and SKF progressive systems, single-line, dual-line and multi-line systems
- Railway lubrication and spray lubrication systems
- Food and beverage
- Chain lubrication systems like Cobra and PMA

Technical data

Function principle	electronic control unit
Operating temperature	-10 to +70 °C; +14 to +158 °F
Inputs	max. 8 digital inputs
Outputs	4 relay outputs, 1 electronic depending on model:
Supply voltage	230 VAC, 24 VDC
Protection class	IP 54
Dimensions	200 × 120 × 90 mm 7.9 × 4.7 × 3.5 in
Mounting position	any

Order information

Order number	Designation
236-10567-6	LMC 2 230 AC (230 VAC)
236-10567-5	LMC 2 24 DC (24 VDC)

For use with electrically driven, 3-phase pump, a motor starter must be ordered separately.



NOTE

Further technical information, technical drawings, accessories, spare parts or product function descriptions available on SKF.com/lubrication:

14004 EN



3D

skf-lubrication.partcommunity.com/3d-cad-models

Control unit

LMC 301



Description

The LMC 301 is a compact, modularly expandable control and monitoring device. The device is equipped with an LCD display and six functional keys for programming, parameter setting and signalization. The user is guided through the setting menu. Also, there is a simple-to-use PC software for parameter setting and diagnostics available.

Features and benefits

- Integrated, flexible lubrication programs
- Basic device with 10 digital inputs, of which two can be used analogously, and eight outputs
- Up to seven extension modules can be added, whereby each module has 10 E 8 A just like the basic device
- Three lubrication pumps can be controlled and monitored, each of which provides up to three lubrication circuits
- Single modules are connected by a bus interface

Applications

- Cement and steel industry
- Mining; stationary and mobile excavators
- Food and beverage

Technical data

Function principle	electronic control unit
Operating temperature VAC	-10 to +50 °C; +14 to +122 °F
Operating temperature VDC	-40 to +70 °C; -40 to +158 °F
Inputs	10 count, short-circuit
Outputs	8 counts, relay outputs NO-contact 8 A, 2 of which up to 20 A
Supply voltage	depending on model: 90-264 VAC, 24 VDC ± 20%
Protection class	IP 65
Dimensions	270 × 170 × 90 mm 10.7 × 6.7 × 3.5 in
Mounting position	vertical

Order information

Order number	Designation
086500	LMC 301; 24 V DC, master, incl. LCD display
086501	LMC 301; 100-240 VAC, master, incl. LCD display
086502	LMC 301; 24 V DC, I/O board, slave, without display
086503	LMC 301; 100-240 AC, I/O board, slave, without display

NOTE

Further technical information, technical drawings, accessories, spare parts or product function descriptions available on SKF.com/lubrication:
15967 EN, 951-150-029 EN



3D
skf-lubrication.partcommunity.com/3d-cad-models

LMC 301 - Accessories



LMC 301 motor relay assembly

Order number	Description
236-10850-7	with motor starter 0,4–0,6 A
236-10850-8	with motor starter 0,6–1,0 A
236-10850-9	with motor starter 1,0–1,6 A
236-10980-6	with motor starter 2,4–4,0 A

LMC 301 housing

Order number	Description
086504	door housing, complete
086505	cable USB

General LMC 301 accessories

Order number	Description
086506 086507	PG-M20 Cable gland kit, IP 65 Multiple cable gasket set (3 x) Cable gasket set (3 x)
3515-10-6020 3515-10-6620	Cable glands PG-M20; complete, with cap nut, cable gasket set, screw plug cartridge Cable gasket set; 2-wire, Ø 0,6 mm Cable gasket set; 4-wire, Ø 0,5 mm
3515-10-7620 3515-10-6320 3515-10-6120	Blind plug Gasket Counter nut
3515-07-6120 3515-10-2021 3515-07-2022 179-990-486 236-11066-1	Conduit glands, IP 65, with flexible metal tube (FMC), UL approved Conduit glands AMG-M 20 x 1,5; UL 514B Counter nut M 20 x 1,5 Protection hose, liquid-proof protective; UL 360 (sold by the metre, when ordering specify the required length) Fuse, blade-type, FK1 3A (32 V) according to ISO 8820-3 Battery, 3 V lithium button cell, model CR3032
www.skf.com/LMC301	LMC 301 software, free download

¹⁾ The installation of the cable glands and cable sets to be provided and done by the customer. The customer is responsible for proper installation.



Overview of pressure sensors

Mechanical pressure sensors with digital output signal

Product	Lubricant		Pressure ranges		Operating temperature		Voltage		Contact type	Page
	oil/fluid	grease	bar	psi	°C	°F	VDC	VAC		
DSA	•	–	1–45	14.5–650	+10 to +60	+50 to +140	30	250	change-over	170
DSD	•	–	0,5–45	7.25–650	–30 to +100	–22 to +212	36	250	change-over	172
DSB	–	•	20–300	290–4 350	–25 to +80	–13 to +176	36	30	change-over	174
69630	•	•	19–207	275–3 000	–25 to +65	–13 to +149	–	125/250/480	NO/NC	176

Digital pressure sensors with digital or analogue output signal

Product	Lubricant		Pressure ranges		Operating temperature		Voltage		Contact type	Page
	oil/fluid	grease	bar	psi	°C	°F	VDC	VAC		
DSC1	1) •	–	0–40	0–580	–25 to +80	–13 to +176	18–30	–	2xPNP	177
DSC2	2) •	–	0–300	0–4 350	–10 to +80	+14 to +176	18–30	–	2xPNP/NPN	178
DSC3	2) •	–	0–300	0–4 350	–25 to +80	–13 to +176	9–35	–	2xPNP	179
234-13161-9	2) •	•	0–250	0–3 625	–25 to +80	–13 to +176	20–32	–	NO/NC 4–20 mA	180
2340-00000118	1) •	•	0–400	0–5 800	–40 to +85	–40 to +185	18–30	–	NO/NC 4–20 mA	181
234-10330-4	1) •	–	0–600	0–8 700	–20 to +85	–4 to +185	24	–	NO/NC 4–20 mA	182
234-11272-4	1) •	•	10–600	145–8 700	–25 to +100	–13 to +212	18–32	–	NO/NC 4–20 mA	183
234-13161-5	2) •	•	0–600	0–8 700	–25 to +80	–13 to +176	20–32	–	NO/NC 4–20 mA	184
2340-00000108	1) •	•	0–600	0–8 700	–40 to +85	–40 to +185	18–30	–	NO/NC 4–20 mA	185

1) Pressure sensor with analogue and digital output signal

2) Pressure sensor with digital output signal

Pressure sensor

DSA



Description

SKF pressure switches of the DSA series monitor the pressure of a centralized lubrication system to assess and help to ensure its proper function. Important monitoring parameters in an intermittently operated centralized lubrication system with single-line metering devices are pressure buildup, pressure head and pressure reduction.

Features and benefits

- Inexpensive mechanical diaphragm pressure switches
- Micro switch is designed as a change-over switch and can be used as both a normally closed contact (NC) and a normally open contact (NO)
- Switches are available for rising and falling pressures from 1 to 30 bar (14.5 to 435 psi) and have non-adjustable increments

Applications

- Machine tools
- Printing machines
- Wind
- Vehicle
- Steel and heavy industries



NOTE

Further technical information, technical drawings, accessories, spare parts or product function descriptions available on SKF.com/lubrication:

1-1701-EN



3D

skf-lubrication.partcommunity.com/3d-cad-models

Technical data

Function principle	digital pressure switch
Lubricant	oil and fluid grease NLGI 000, 00, 0 oiled compressed air
Operating temperature	+10 to +60 °C; +50 to +140 °F
Operating pressure ¹⁾	max. 45 bar; max. 650 psi
Switching pressure range	1 to 30 bar; 14.5 to 435 psi
Switch type	micro switch
Contact type	change-over
Contact rating	max. 125 VA
Switch current	min. 2 mA, max. 300 mA
Switching rate	max. 30 per min
Switching voltage	max. 250 VAC / 30 VDC
Electrical connection ²⁾	DIN EN 175301-803, plug
Connection fitting	∅ 6 mm; connector DIN 3862, for solderless pipe union, plug connector for pipe
Materials:	
Housing	PA6 6GF30
Contact	AuAg25Pt6
Membrane	FKM (FPM)
Protection class with cable box	IP 65
Safety class	II
Dimensions	min. 76 × 120 × 41 mm max. 83 × 129 × 41 mm min. 3.0 × 4.7 × 1.6 in max. 3.3 × 5.1 × 1.6 in
Mounting position	any

¹⁾ A pressure-regulating valve must be installed in the system to prevent operating pressure from exceeding the permissible level
²⁾ M 12x1 circular plug, only for design with electrical connection center

Pressure sensor

DSA

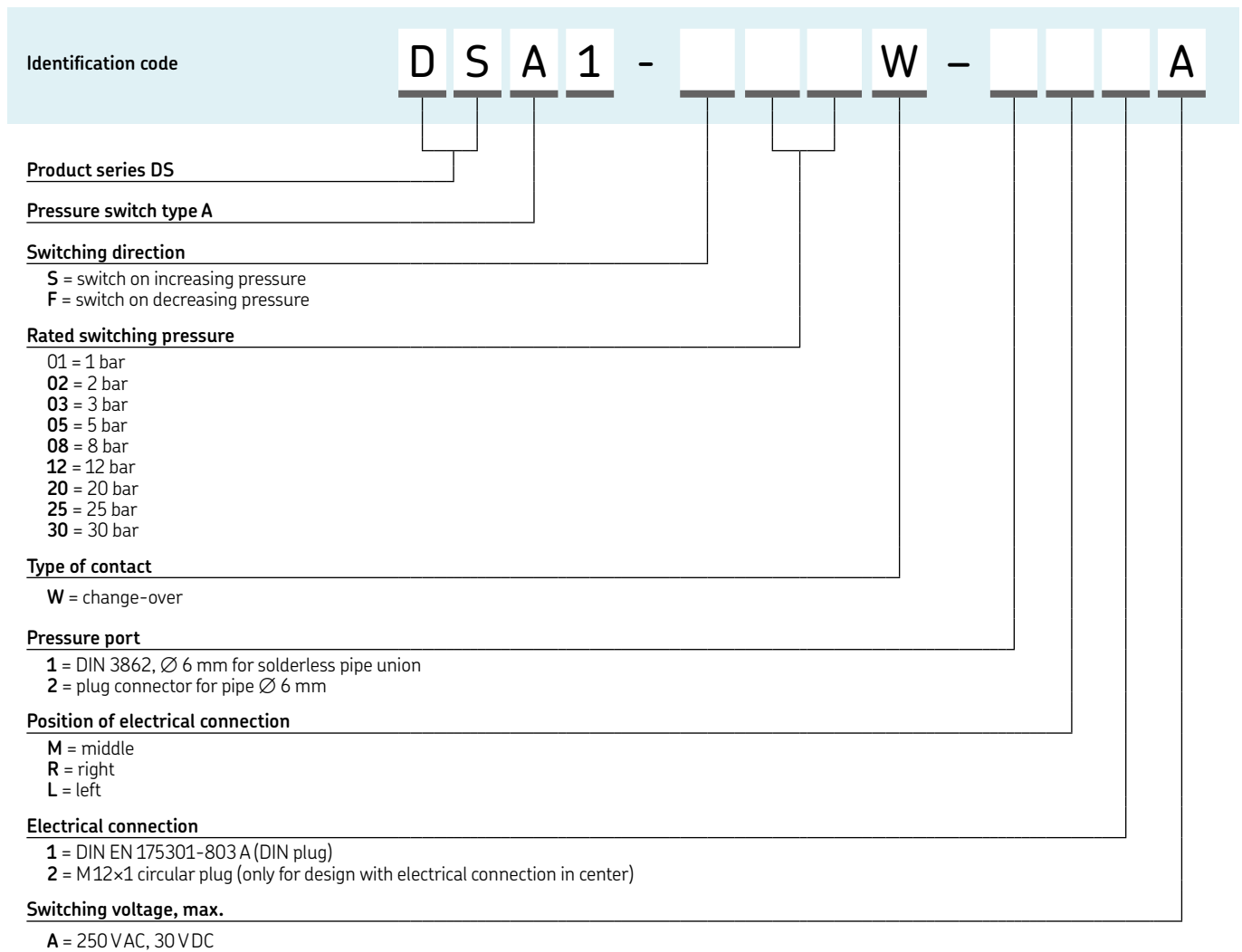

Pressure sensor

DSD



Description

DSD sensors are single, mechanical-diaphragm pressure switches. They are used for pressure monitoring and are dependent upon the mechanical design of resulting pressure and preloaded spring force of the pressure spring. Under pressure, a pressure plunger carries the contact washer and moves it to the opposing contact and closes the electrical circuit. If the pressure is reduced by the amount of hysteresis, the switch opens again. On an NC contact, contacts are made in the opposite way. In single-line systems, it can be integrated into metering devices at the end of the lubrication line.

Features and benefits

- Available for a pressure rating from 0 to 45 bar in fixed increments
- Electrical connection is established via screwed contacts, tab connectors, circular connectors or rectangular plug connectors
- Pressure monitoring, dependent upon the mechanical design of resulting pressure and preloaded spring force of the pressure spring
- Mechanical switch can be used as both a normally closed contact (NC) and a normally open contact (NO)

Applications

- Machine tools
- Printing machines
- Vehicles



Technical data

Function principle	digital pressure switch
Lubricant	oil and fluid grease NLGI 000, 00, 0
Operating temperature	-30 to +100 °C; -22 to +212 °F
Operating pressure	static: max. 300 bar; max. 4 350 psi dynamic: max. 150 bar; max. 2 175 psi
Switching pressure	0,5 to 45 bar; 7.25 to 653 psi
Switch type	mechanical diaphragm pressure switch
Contact type	NO, NC (change-over with rectangular plug connector only)
Contact rating	max. 18 VA, 90 VA, 100 VA
Switching voltage/current	36 VDC/2,5 A/0,5 A 250 VAC/5 A
Electrical connection	M3 or M12x1 or DIN EN 175301-803-A
Pressure port	M10x1 tapered G 1/8 on request
Materials:	
Housing	steel, galvanized, Cr6-free
Contact	silver plated
Membrane	NBR or FKM
Protection class	IP 65
Dimensions	depending on model, Ø x h 26,75 x 50 mm; 1.05 x 1.97 in 26,75 x 49 mm; 1.05 x 1.93 in
Mounting position	any



NOTE

Further technical information, technical drawings, accessories, spare parts or product function descriptions available on SKF.com/lubrication:

1-1701-EN



3D

skf-lubrication.partcommunity.com/3d-cad-models

Pressure sensor

DSD

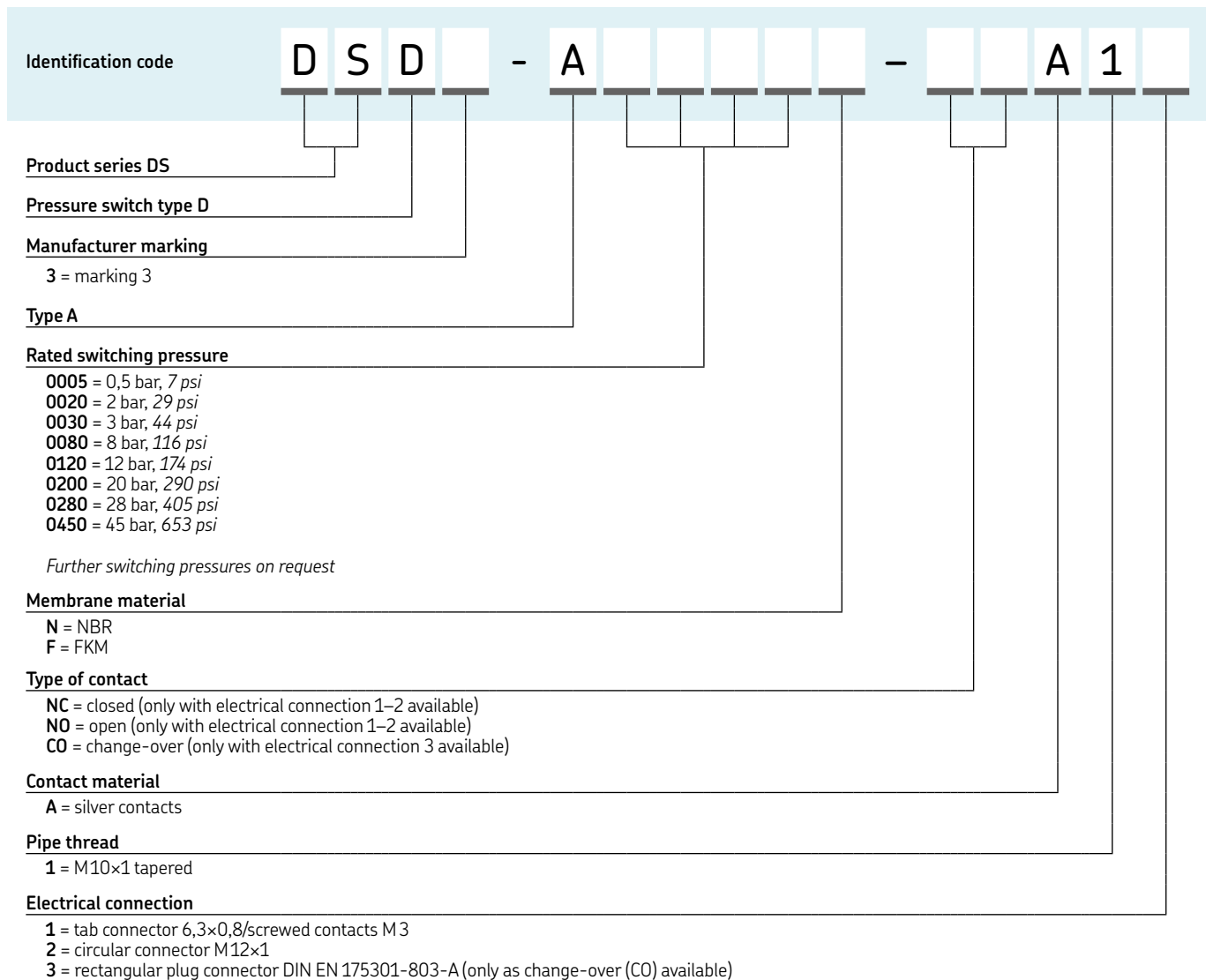

Pressure sensor

DSB1



Description

SKF pressure switches of product series DSB are mechanical piston pressure switches that are specially designed for use with NLGI 1-2 greases. The location of the actuating piston inside the pressure switch housing helps to ensure a continuous exchange of grease around the measuring point (pressurization point between grease and actuating piston). This reliably prevents the same grease from being pressurized repeatedly, which could cause grease bleeding (separation of the soap skeleton of the grease from the stored oil). Pressure switches of product series DSB are designed for corrosivity category C3 or C5M per ISO 12944.

Features and benefits

- Adaptable to VR lubricant metering devices due to same hole pattern, wall distance and connections
- Micro switch is designed as a change-over switch; can be used as both a normally closed contact (NC) and a normally open contact (NO)
- Available for rising and falling pressures from 20 to 300 bar in 10-bar increments
- No grease bleeding at measuring point
Pressure switch permits continuous lubricant flow without dead space
- Suitable for use with unstable greases with a tendency to separate into soap and oil under high pressure

Applications

- Machine tools
- Printing machines
- Wind
- Vehicle
- Steel and heavy industries

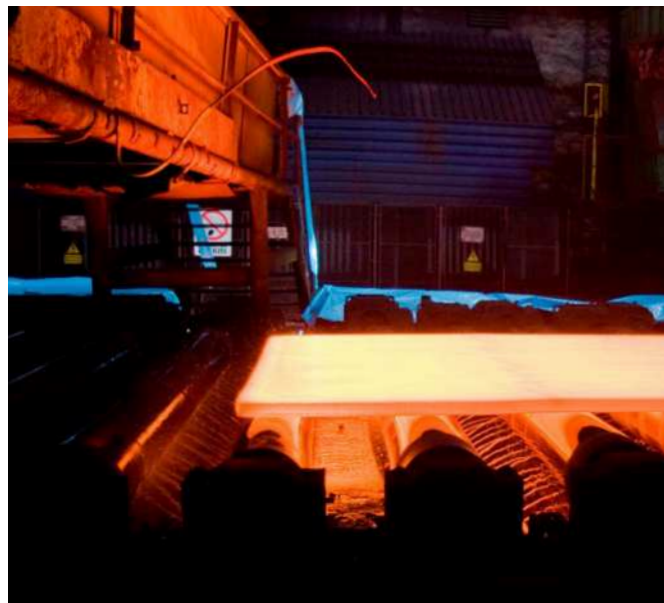

Technical data

Function principle	digital pressure switch
Lubricant	grease NLGI 1, 2
Operating temperature	-25 to +80 °C; -13 to +176 °F
Operating pressure	max. 300 bar; 4 350 psi
Operating voltage	max. 30 VAC; max. 36 VDC
Operating current	max. 50 mA, min. 1 mA
Breaking capacity	max. 1,2 VA
Mechanical service life	10 ⁵ switching cycles
Pressure port	G 1/4 (F)
Electrical connection	connector socket 3+PE; DIN EN 175 301-803 A cable: Ø 4.5 to 7 mm; Ø 0.177 to 0.275 in
Switch type	micro switch
Contact type	change-over
Switching pressure range	20 to 300 bar; 290 to 4 350 psi; increasing and decreasing
Materials:	
Housing	aluminum, anodized
Contact	silver alloy, hard gold plating
Protection class	IP 65; DIN EN 60529
Dimensions	depending on model min. 60 × 105 × 76 mm; max. 150 × 153 × 76 mm; min. 2.36 × 4.13 × 2.99 in max. 5.90 × 6.02 × 2.99 in
Mounting position	any
Certification	Germanischer Lloyd (GL)

NOTE

Further technical information, technical drawings, accessories, spare parts or product function descriptions available on SKF.com/lubrication:

1-1701-EN



3D

skf-lubrication.partcommunity.com/3d-cad-models

Pressure sensor

DSB1

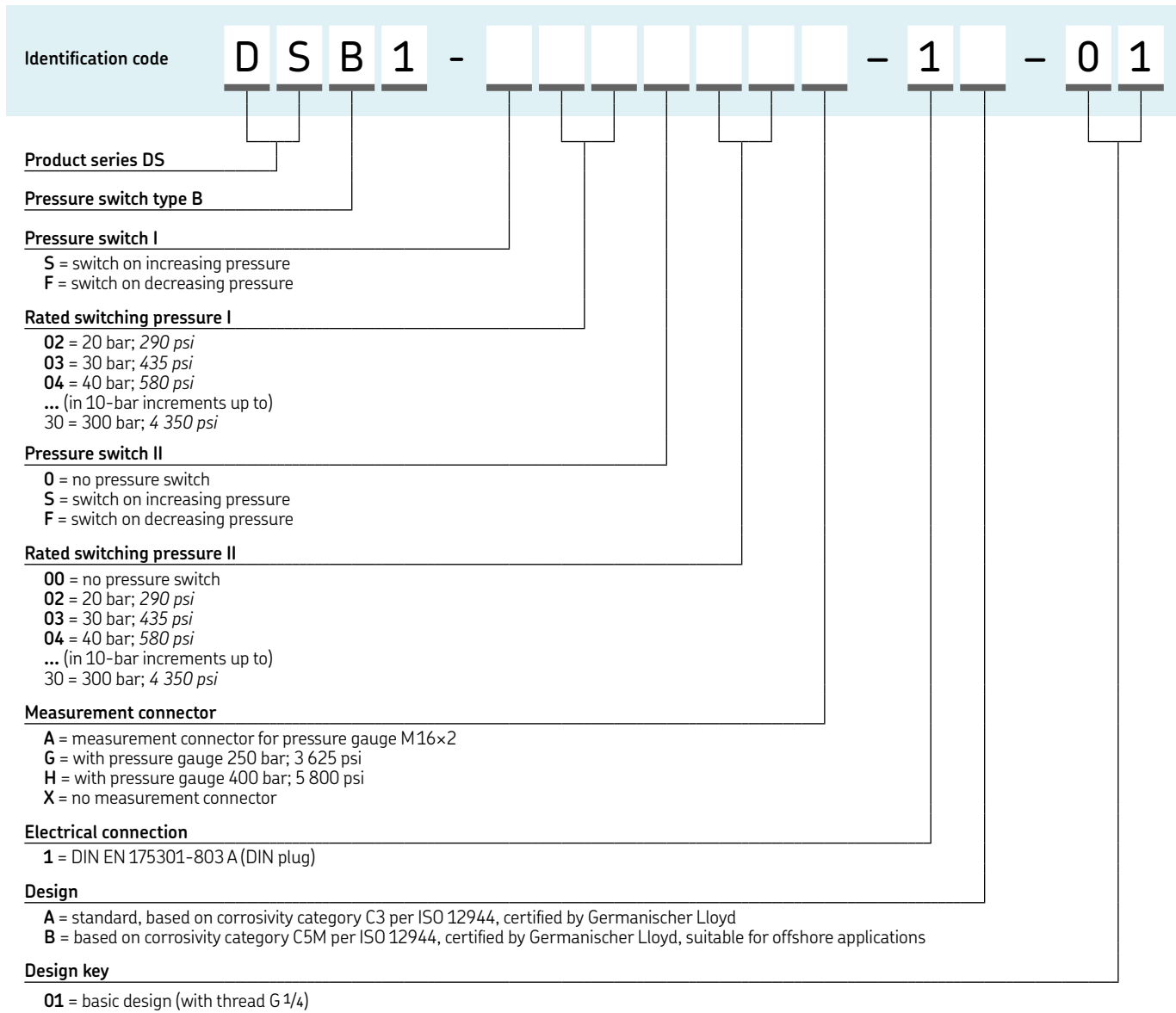

Pressure sensor

69630



Description

Pressure switch 69630 senses supply line pressure when pressure is rising or falling. One single contact signals system operation to controller or system alarm.

Features and benefits

- Simple pressure switch
- Adjustable pressure ranges for decreasing and increasing pressures to match system requirements
- Use as single pressure switch or in a system with controller and solenoid valve

Applications

- Paper converting
- Plastic processing
- Printing
- Packaging
- Metalworking
- Material handling equipment

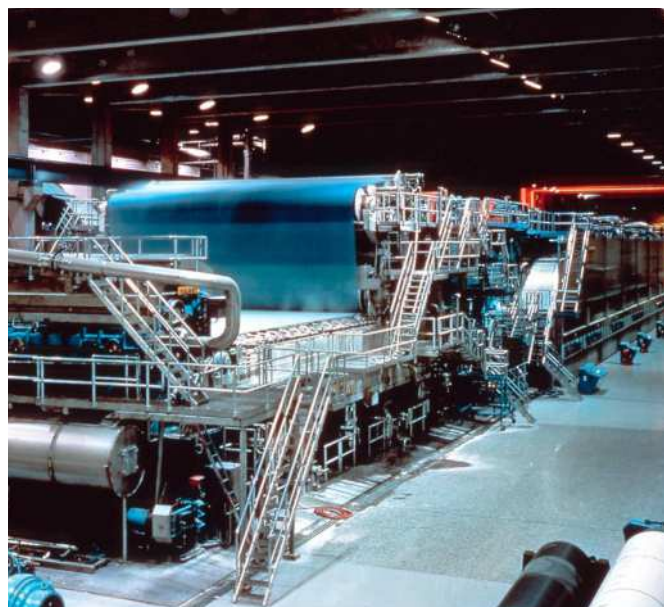

Technical data

Order number	69630
Function principle	digital pressure switch
Operating temperature	-25 to +65 °C -13 to +150 °F
Switching capacity	125, 250 or 480 VAC: 10 A 6 VDC: 15 A 24 VDC: 5 A 250 VDC: 0,3 A
Operating pressure:	
decreasing	max. 190 bar max. 2 775 psi
increasing	max. 207 bar max. 3 000 psi
Pressure port	1/4 NPTF (F)
Electrical connection	27/32 in hole for conduit connector 1/2 in housing and UL-listed switching elements: NEMA 3
Protection class	
Dimensions	57 × 146 mm 2.25 × 5.75 in
Mounting position	vertical



NOTE

Further technical information, technical drawings, accessories, spare parts or product function descriptions available on SKF.com/lubrication:

442832



3D

skf-lubrication.partcommunity.com/3d-cad-models

Pressure sensor

DSC1



Description

DSC1 pressure switches are electronic pressure switches with integrated digital display for relative pressure measurement. They are used primarily for pressure monitoring. Depending on the design, they also can assume control functions. Pressure switch points, pressure indication, and the switching logic can be configured and programmed easily. The values are displayed as 4-digit alphanumeric characters, at the same time there is an alternating display (red / green) to indicate the switching status. DSC1 can be operated with both hysteresis and window functions and the mode can be set separately for each switching output.

Features and benefits

- IO-Link
- Available for rising and falling pressures from 1 to 40 bar in 0,5 bar increments
- Can be operated with both, hysteresis and window function modes
- Encodable access protection
- Digital and analog output

Applications

- Machine tools
- Printing machines
- Wind
- Vehicle
- Steel and heavy industries

Technical data

Order number	DSC1-B040E-2A2B
Function principle	analogue/digital pressure switch
Lubricant	oil and fluid grease NLGI 000, 00, 0
Operating temperature	-25 to +80 °C -13 to +176 °F
Operating pressure	1-40 bar in 0,5 bar steps 14-580 psi in 7 psi steps
Burst pressure	500 bar; 7 251 psi
Operating voltage	18 to 30 VDC
Power consumption	max. 35 mA
Output signal	2 signal outputs; 1 x PNP transistor stages or IO-Link
Vibration resistance	20 g (10-2 000 Hz)
Service life	100 × 10 ⁶ pressure changes
Material:	
Housing	stainless steel
Control panel	polycarbonate
Electrical connection	M12×1; 4-pin
Pressure port	G 1/4
Protection class	IP 67
Dimensions	34 × 91 × 49,4 mm 1.33 × 3.58 × 37.4 in
Mounting position	any



NOTE

Further technical information, technical drawings, accessories, spare parts or product function descriptions available on SKF.com/lubrication:

1-1701-EN

Pressure sensor

DSC2



Description

DSC2 sensors are electronic pressure switches with an integrated digital display for relative pressure measurement. They are used primarily for pressure monitoring. Depending on the design, they also can assume control functions. Pressure switch points, pressure indication and the switching logic can be configured and programmed easily. The four-digit, digital display that indicates switching with LEDs. DSC2 can operate in switching point, hysteresis and window function modes. The switching mode can be programmed separately for each output.

Features and benefits

- Available for rising and falling pressures from 0 to 100 bar in 0.5-bar increments
- Four-digit, digital display indicates switching with LEDs
- Can operate in switching point, hysteresis and window function modes
- Diagnostic output based on the DESINA specification
- UL certification

Applications

- Machine tools
- Printing machines
- Wind
- Vehicle
- Steel and heavy industries



Technical data

Order number	DSC2-A100E-2A2B
Function principle	digital pressure switch
Lubricant	oil and fluid grease NLGI: 000-0
Operating temperature	-10 to +80 °C +14 to 176 °F
Operating pressure	max. 300 bar max. 4 350 psi
Operating voltage	18 to 30 VDC
Power consumption	max. 35 mA
Output signal	2 x PNP/NPN
Vibration resistance	20 g (10-2 000 Hz)
Service life	100 × 10 ⁶ pressure changes
Material:	
Housing	aluminum, stainless steel
Control panel	polyester film
Electrical connection	M12×1, 4-pin
Pressure port	G 1/4 (F)
Protection class	IP 67
Dimensions	34 × 90,7 × 49,4 mm 1.33 × 3.57 × 37.4 in
Mounting position	any



NOTE

Further technical information, technical drawings, accessories, spare parts or product function descriptions available on SKF.com/lubrication:

1-1701-EN



3D

skf-lubrication.partcommunity.com/3d-cad-models

Pressure sensor

DSC3



Description

DSC3 sensors are electronic pressure switches with an integrated digital display for relative pressure measurement. They are used primarily for pressure monitoring. Depending on the design, they also can assume control functions. Pressure switch points, pressure indication and the switching logic can be configured and programmed easily. The display is a pivoted, four-digit, digital display. DSC3 can be integrated into lubrication line. It operates in switching point, hysteresis, and window function modes. The switching mode can be programmed separately for each output.

Features and benefits

- Available for rising and falling pressures from 0 to 100 bar in 0.5-bar increments
- Easy to install into a lubrication line
- Pivoted, four-digit, digital display
- Can operate in switching point, hysteresis and window function modes
- Programming lock to protect against unauthorized adjustment of drive
- Switching displayed using LEDs

Applications

- Machine tools
- Printing machines
- Wind
- Vehicle
- Steel and heavy industries

Technical data

Order number	DSC3-A100K-3A2B
Function principle	digital pressure switch
Lubricant	oil and fluid grease NLGI: 000-0
Operating temperature	-25 to +80 °C -13 to 176 °F
Operating pressure	max. 300 bar max. 4 350 psi
Operating voltage	9 to 35 VDC
Power consumption	max. 35 mA
Output signal	2 x PNP transistor stages
Vibration resistance	20 g (5-500 Hz)
Service life	100 × 10 ⁶ pressure changes
Material:	
Housing	plastic
Electrical connection	M12×1, 4-pin
Pressure port	via t connector, 2 × G 1/8 (F)
Protection class	IP 67
Dimensions	42 × 115 × 40 mm 1.65 × 4.53 × 1.57 in
Mounting position	any



NOTE

Further technical information, technical drawings, accessories, spare parts or product function descriptions available on SKF.com/lubrication:

1-1701-EN



3D

skf-lubrication.partcommunity.com/3d-cad-models

Pressure sensor

234-13161-9



Description

This compact, maintenance-free electronic pressure switch has a 3-digit, digital display, one switching output and an analog output signal for switching point and hysteresis. Both can be adjusted via push buttons. For optimum adaptation to a particular application, the instrument has many additional adjustment parameters, e.g. switching delay times, NO and NC function of the outputs.

Features and benefits

- Integrated pressure sensor with thin-film strain gauge on stainless steel membrane
- 3-digit, digital display
- Independently adjustable switch-back hysteresis and switching point
- Reverse polarity protection of the supply voltage, excess voltage, override and short-circuit protection are provided
- Password protected
- Directly installable via G 1/4 adapter into pressure line

Applications

- Marine and off-shore applications
- Steel and heavy industries
- Wind turbines
- Service vehicles



Technical data

Order number	234-13161-9
Function principle	digital pressure switch
Lubricant	oil, fluid grease and grease up to NLGI 2
Operating temperature	-25 to +80 °C; -13 to +175 °F
Operating pressure	max. 250 bar; max. 3 625 psi
Operating voltage	20-32 VDC
Output signal	1 × PNP, 4-20 mA
Current consumption	approx. 100 mA (without switching outlet)
Electrical connection	plug DIN 43650 (3pin+ PE) or plug 4-pin binder 714, M18 × 1
Pressure port	G1/4
Protection class	IP 65
Dimensions	35 × 119 × 48 mm 1.37 × 4.68 × 1.89 in
Mounting position	any



NOTE

Further technical information, technical drawings, accessories, spare parts or product function descriptions available on SKF.com/lubrication.

Pressure sensor

2340-00000118



Description

This maintenance-free analogue pressure sensor is suitable for pressure measurements for gases and fluids. It is user friendly and can be applied easily in standard or superior applications. The space-saving housing is pivotable up to 320° for optimal readability of the 4-digit, digital display. Switching output for analogue or digital signals incl. IO-Link. It comes with reverse polarity protection of the supply voltage, excess voltage, override and short circuit protection. Different value units such as bar, mbar, psi or MPa can be selected.

Features and benefits

- IO-link incl. counter for operating hours, pressure peaks and inner temperature
- Menu-guided adjustments via push buttons
- Pre-adjustable hysteresis
- Programmable parameters, password protected
- Compact housing with 320° pivot

Applications

- Marine and off-shore applications
- Steel and heavy industries
- Wind turbines
- Service vehicles



Technical data

Order number	2340-00000118
Function principle	analogue/digital pressure switch, flush oil, fluid grease and grease up to NLGI 2
Lubricant	CE, EAC, UL/CSA
Approval	CE, EAC, UL/CSA
Operating temperature	-40 to +85 °C; -40 to +185 °F
Operating pressure	max. 400 bar; max. 5 800 psi
Overload pressure	600 bar; 8 700 psi
Burst pressure	1 000 bar; 14 500 psi
Operating voltage	18-30 VDC
Operating current	max. 150 mA
Current draw	≤ 50 mA
Output signal	2x PNP/NPN (NO/NC) adjustable voltage 0 .. 10 V / current 4 .. 20 mA adjustable
Analogue Output	IO-Link 1.1
Interface	170 Hz
Switching frequency	100 Mio.
Switching cycles	
Material:	
Housing	PA6.6, stainless steel 1.4301, FKM
Measuring cell	Stainless steel 1.4435
Electrical connection	M12x1; 4-pole, A-coded
Pressure port	G1/2
Protection class	IP 67
Dimensions	116 x 34 x 49 mm 4.56 x 1.33 x 1.92 in
Mounting position	any



NOTE

Further technical information, technical drawings, accessories, spare parts or product function descriptions available on SKF.com/lubrication.

Pressure sensor

234-10330-4



Description

This electronic pressure switch has a 4-digit, digital display, two switching outputs and an analog output signal for switching point and hysteresis. Both can be adjusted via push buttons. The water-proofed housing is pivotable up to 290° for optimal readability of digital display. The pressure switch is virtually maintenance free.

Features and benefits

- Menu-guided adjustments via 3 push buttons indicating status of outputs
- Peak value storage
- Adjustable hysteresis and absorption
- Programmable parameters
- Password protected
- Reverse polarity and overvoltage protected; short-circuit proof

Applications

- Machine tools
- Printing machines
- Wind
- Vehicles
- Steel and heavy industries

Technical data

Order number	234-10330-4
Function principle	analogue/digital pressure switch
Lubricant	oil, fluid grease and grease up to NLGI 2
Operating temperature	-20 to +85 °C; -4 to +185 °F
Operating pressure	0-600 bar; 0-8 700 psi
Overload pressure	1 200 bar; 17 400 psi
Burst pressure	2 400 bar; 34 800 psi
Analog output signal	0/4-20 mA, apparent ohmic resistance ≤ 500 Ω
Operating voltage	15-30 VDC, nominal 24 VDC
Signal output type	PNP-Transistor
Switching current	max. 0,7A
Current consumption	< 100 mA
Switching cycle	≥ 20 Mio.
Electrical connection	M12 × 1; 5 pin
Pressure port	G 1/4 (BSPP)
Material:	
Housing	stainless steel 1.4404, NBR
Control panel	zinc die casting, surface treated
Protection class	IP 67
Dimensions	39,5 × 105,5 × 46,3 mm 1,55 × 4,15 × 1,82 in
Mounting position	any



NOTE

Further technical information, technical drawings, accessories, spare parts or product function descriptions available on SKF.com/lubrication.

Pressure sensor

234-11272-4



Description

The electronic pressure switch with internal stainless steel diaphragm, suits for pressure control in automatic single-line lubrication systems. It has a 4 digit 7 segment digital display, two solid state contacts or two solid state contacts plus one analog output for switching point and hysteresis. All contacts can be adjusted via push buttons. The pressure switch is virtually maintenance free.

Features and benefits

- Alphanumeric 4-digit 7 segment LED display
- Microprocessor controlled
- Self monitoring with error display
- Scalable analog output
- Programmable parameters via keypad
- Adjustable password protection
- Revers polarity and overvoltage protected, short-circuit proof max 60 VDC temporary
- Rugged stainless steel construction
- Vibration and shock-proof, longterm stability

Applications

- Machine tools
- Chemical technics
- Wind, vehicle, steel and heavy industries
- Automation

Technical data

Order number	234-11272-4
Function principal	electrically operated dual output signal analogue/digital pressure switch
Lubricant	oil, fluid grease and grease up to NLGI 2
Operating temperature	-25 to +100 °C ; -13 to +212 °F
Operating pressure	10 to 600 bar; 145 to 8702 psi
Operating elements	3 easy-response push buttons
Protection class	IP 65 with plug
Pressure port	G 1/4 M
Electrical connection	M12 x 1; for 4 pin or 5 pin plug
Current output	4-20 mA, apparent ohmic resistance 600 Ω at 24 VDC
Power supply	18-32 VDC reversed polarity protected (SELV, PELV)
Digital display	4-digit 7 segment LED display
Power consumption	approx. 50 mA at 24 VDC without load
Material:	
Wetted parts	stainless steel 1.4301
Electronics housing	aluminum die-cast
Seals	FKM
Dimensions	75 x 130 x 55 mm 2.95 x 5.12 x 2.16 in
Mounting position	vertical



NOTE

Further technical information, technical drawings, accessories, spare parts or product function descriptions available on SKF.com/lubrication.

Pressure sensor

234-13161-5



Description

This compact, maintenance-free electronic pressure switch has a 3-digit, digital display, one switching output and an analog output signal for switching point and hysteresis. Both can be adjusted via push buttons. For optimum adaptation to a particular application, the instrument has many additional adjustment parameters, e.g. switching delay times, NO and NC function of the outputs.

Features and benefits

- Integrated pressure sensor with thin-film strain gauge on stainless steel membrane
- 3-digit, digital display
- Independently adjustable switch-back hysteresis and switching point
- Reverse polarity protection of the supply voltage, excess voltage, override and short-circuit protection are provided
- Password protected
- Directly installable via G 1/4 adapter into pressure line

Applications

- Marine and off-shore applications
- Steel and heavy industries
- Wind turbines
- Service vehicles



Technical data

Order number	234-13161-5
Function principle	digital pressure switch
Lubricant	oil, fluid grease and grease up to NLGI 2
Operating temperature	-25 to +80 °C; -13 to +175 °F
Operating pressure	max. 600 bar; max. 8 700 psi
Operating voltage	20-32 VDC
Output signal	1 × PNP, 4-20 mA
Current consumption	approx. 100 mA (without switching outlet)
Electrical connection	plug DIN 43650 (3pin+ PE) or plug 4-pin binder 714, M18 × 1
Pressure port	G1/4
Protection class	IP 65
Dimensions	35 × 119 × 48 mm 1.37 × 4.68 × 1.89 in
Mounting position	any



NOTE

Further technical information, technical drawings, accessories, spare parts or product function descriptions available on SKF.com/lubrication.

Pressure sensor

2340-00000108



Description

This maintenance-free analogue pressure sensors is suitable for pressure measurements for gases and fluids. It is user friendly and can be applied easily in standard or superior applications. The space-saving housing is pivotable up to 320° for optimal readability of the 4-digit, digital display. Switching output for analogue or digital signals incl. IO-Link. It comes with reverse polarity protection of the supply voltage, excess voltage, override and short circuit protection. Different value units such as bar, mbar, psi or MPa can be selected.

Features and benefits

- IO-link incl. counter for operating hours, pressure peaks and inner temperature
- Menu-guided adjustments via push buttons
- Pre-adjustable hysteresis
- Programmable parameters, password protected
- Compact housing with 320° pivot

Applications

- Marine and off-shore applications
- Steel and heavy industries
- Wind turbines
- Service vehicles

Technical data

Order number	2340-00000108
Function principle	analogue/digital pressure switch
Lubricant	oil, fluid grease and grease up to NLGI 2
Approval	CE, EAC, UL/CSA
Operating temperature	-40 to +85 °C; -40 to +185 °F
Operating pressure	max. 600 bar; max. 8 700 psi
Overload pressure	1 000 bar; 14 500 psi
Burst pressure	1 570 bar; 22 770 psi
Operating voltage	18-30 VDC
Operating current	max. 150 mA
Current draw	≤ 50 mA
Output signal	2x PNP/NPN (NO/NC) adjustable
Analogue Output	voltage 0 .. 10 V / current 4 .. 20 mA adjustable
Interface	IO-Link 1.1
Switching frequency	170 Hz
Switching cycles	100 Mio.
Material:	
Housing	PA6.6, stainless steel 1.4301, FKM
Measuring cell	Ceramics Al2O3
Apapter	stainless steel
Electrical connection	M12x1; 4-pole, A-coded
Pressure port	G1/4
Protection class	IP 67
Dimensions	95 x 34 x 49 mm 3.74 x 1.33 x 1.92 in
Mounting position	any



NOTE

Further technical information, technical drawings, accessories, spare parts or product function descriptions available on SKF.com/lubrication.



Overview of flow monitors and sensors

Digital flow sensors with digital output signal

Product	Lubricant		Function type	Operating temperature		Voltage		Page
	oil/fluid	grease		°C	°F	VDC	VAC	
GS204P	•	–	Digital oil flow sensor	+10 to +50	+50 to +122	24	–	188

Hose connection monitor

Product	Lubricant		Function type	Operating temperature		Voltage		Page
	oil/fluid	grease		°C	°F	VDC	VAC	
HCC	•	•	Monitoring device for hose connections	-50 to +70	-58 to +158	12/24	–	189

Flow sensor

GS304P

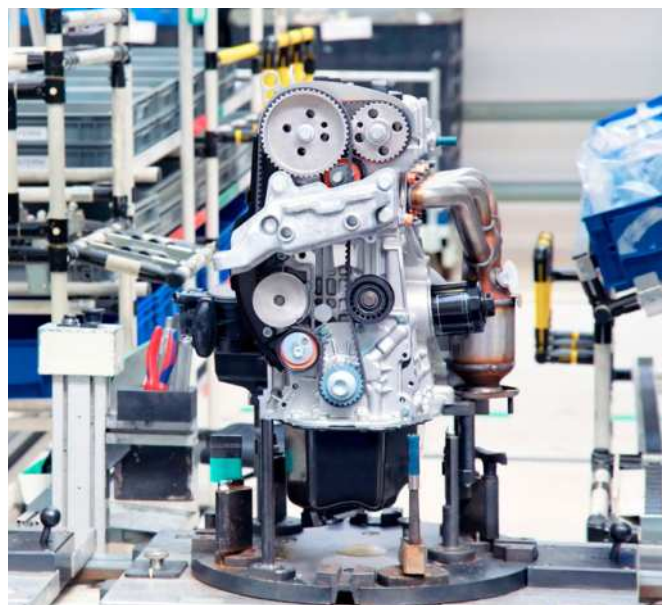

Description

Flow sensors keep an eye on the flow of oil from a metering point to the lubrication point, metering out a small amount of oil for only a short period of time. They are suitable for intermittent, centralized lubrication systems e. g. with piston metering devices, metering elements, injection oilers, oil and air centralized lubrication systems.

Features and benefits

- Provide simple control
- Monitor flow of lubricant from the metering point to the lubrication point
- Meter out a small amount of oil for only a short period of time

Applications

- Machine tools
- Automotive manufacturing
- Industrial assembly and automation



NOTE

Further technical information, technical drawings, accessories, spare parts or product function descriptions available on SKF.com/lubrication:

1-1704-EN



3D

skf-lubrication.partcommunity.com/3d-cad-models

Technical data

Order number	GS304P
Function principle	flow sensor
Measuring principle	calorimetric
Lubricant 1)	oil (10 to 2 000 mm ² /s)
Metering quantity	0,01 - 0,6 cm ³ /pulse 0.0006 - 0.03 in ³ /pulse
Clock frequency 2)	max. 4 pulse/min
Operating temperature	+10 to +50 °C, +50 to +122 °F
Operating pressure	max. 40 bar; 580 psi
Rated voltage	24 VDC
Residual ripple	10%
Working range UA	18 to 30 VDC
Max. power consumption IE	25 mA
Pulse output	3 s
Load current IA for GS300 for GS304	max. 10 mA max. 500 mA per output
Output protection	short-circuit protection
Built-in plug	circular connector with M12x1 screw plug
Fluid connection	M 8x1 mm, port tapped for solderless Ø 4 mm tube connection
Dimensions	95 x 50 x 20 mm 3.74 x 1.96 x 0.78 in
Mounting position	directly upstream of lubrication point
Vibration resistance	20 g (DIN / IEC 68-2-27, 10-2000 Hz)
Impact resistance	50 g (DIN / IEC 68-2-27, 11 ms)

1) Sensor needs 30 sec. of warm-up time

2) The use of oils containing corrosive and/or abrasive additives may impair sensor function and possibly damage the sensor

Hose connection control unit

HCC



Description

The hose connection control (HCC) is intended to monitor electrically conductive, high-pressure lubrication hoses for line breakage. If there is a fault in the main line or feed lines, the unit alerts the machine operator immediately. Operation of the HCC is not affected by line lengths, ambient temperature, pressure differential or pressure losses. Utilizing non-conductive lubricants or hydraulic fluids, this monitoring system has an operating pressure of up to 300 bar (4 350 psi) and can be used in temperatures ranging from -40 to $+70$ °C (-40 to $+158$ °F).

Features and benefits

- Immediately detects hose ruptures
- Expandable at any time
- Easy retrofit in existing lubrication systems
- Monitors difficult-to-access hoses to lubrication points
- Common LED signal of all connected hoses on the display

Applications

- Construction and mining machines; cranes, forklifts
- Wood-handling and agriculture machine



NOTE

Further technical information, technical drawings, accessories, spare parts or product function descriptions available on SKF.com/lubrication:

16966 EN, 951-170-232



3D

skf-lubrication.partcommunity.com/3d-cad-models

Technical data

Function principle	control and monitoring device for hose connections
Operating temperature	Isolator: -50 to $+70$ °C; -58 to $+158$ °F Controller: -25 to $+70$ °C; -13 to $+158$ °F Controller storage: -40 to $+70$ °C; -40 to $+158$ °F
Power supply	12/24 V DC
Monitored hose per monitoring unit	max. 15 pieces at 12 V DC max. 24 pieces at 24 V DC
Positive ok signal	12/24 V PNP
Signal cable to one cut-off connector	20 m; 65 ft
Signal cable at cut-off	approx. 150 mm; 5.90 in
Protection class	IP 65
Dimensions	100 × 85 × 40 mm 3.93 × 3.34 × 1.57 in

Order information

Order number	Designation
236-10986-1	HCC, evaluation unit
236-10153-3	HCC, with cable 20 m
532-34839-2	HCC, endlink HCC DN 8-10L-E
532-37731-1	basic kit consisting of above three parts
532-34839-6	HCC, endlink HCC DN 4-6L-E
532-34839-3	HCC, interlink HCC DN 8-10L-I
532-34839-5	HCC, Interlink HCC DN 4-6L-I

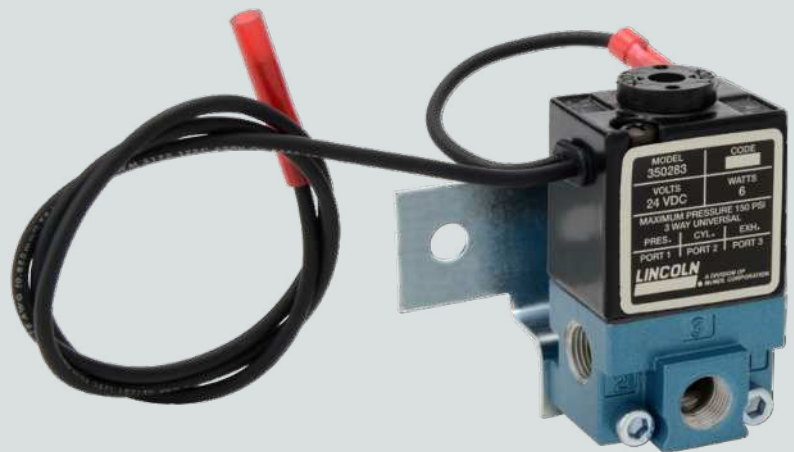

Overview of solenoid valves

Solenoid valves								
Product	Type	Operating pressure max.		Operating temperature		Voltage		Page
		bar	psi	°C	°F	V DC	V AC	
350241	3-way	10,3	150	-18 to +60	0 to 140	–	110–240	192
350242	3-way	10,3	150	-18 to +60	0 to 140	–	110–240	192
350244	4-way	10,3	150	-18 to +49	0 to 120	–	110–240	192
350245	4-way	10,3	150	-18 to +49	0 to 120	–	110–240	192
350282	3-way	10,3	150	-18 to +60	0 to 140	12	–	193
350283	3-way	10,3	150	-18 to +60	0 to 140	24	–	193
253-14076-6	3/2-way	0,5–16	7,3–232	-10 to +55	14 to 131	–	110	194
253-14076-7	3/2-way	0,5–16	7,3–232	-10 to +55	14 to 131	–	230	194
525-32085-1	3/2-way	0–400	0–5 800	-20 to +60	-4 to +140	24	–	195
525-32086-1	3/2-way	0–400	0–5 800	-20 to +60	-4 to +140	–	110	195
525-32087-1	3/2-way	0–400	0–5 800	-20 to +60	-4 to +140	–	230	195
161-110-031	2/2-way	max. 500	max. 7 250	-25 to +80	-13 to +176	24	–	196
161-140-050	4/2-way	max. 320	max. 4 350	-25 to +80	-13 to +176	24	220	197

Solenoid valve

35024 ...



Description

Electric solenoid-operated air valves 350241 to 350245 operate as 3-way or 4-way solenoid air valves. They are used to operate single-stroke or reciprocating-stroke, air-controlled pumps in single-line systems. Timer- and pressure-controlled air is supplied to the pumps, activating air-powered forward strokes and spring- (3-way) or air-powered (4-way) return strokes. In doing so, pumps discharge lubricant to the connected metering devices.

Features and benefits

- Timer- and pressure-controlled pump operation
- Use as 3-way or 4-way solenoid valves
- For operation of single-stroke or reciprocating-stroke pumps
- Flexible usage selectable on electrical VAC power requirements

Applications

- Mining and mineral processing
- Heavy machines

Technical data

Function principle	
Model 350241, 350242	3-way, solenoid-operated air valve
Model 350244, 350245	4-way, solenoid-operated air valve
Operating temperature	
Model 350241, 350242	-18 to +60 °C, 0 to +140 °F
Model 350244, 350245	-18 to +49 °C, 0 to +120 °F
Operating pressure	max. 10 bar; 150 psi
Operating voltage	110–240 VAC
Current	8,4 A
Current inrush	
Model 350241, 350244	0,11 A
Model 350242, 350245	0,055 A
Current holding	
Model 350241, 350244	0,7 A
Model 350242, 350245	0,35 A
Air inlet/outlet	1/4 NPT (F)
Conduit connection	1/2 NPS (F)
Mounting position	any

Order information

Order number	Designation	Type
350241	110 VAC, 50 Hz, 120 VAC, 60 Hz, 8,4 VA	3-way
350242	220 VAC, 50 Hz, 240 VAC, 60 Hz, 8,4 VA	3-way
350244	110 VAC, 50 Hz, 120 VAC, 60 Hz, 8,4 VA	4-way
350245	220 VAC, 50 Hz, 240 VAC, 60 Hz, 8,4 VA	4-way



NOTE

Further technical information, technical drawings, accessories, spare parts or product function descriptions available on SKF.com/lubrication.

Solenoid valve

350282, 350283

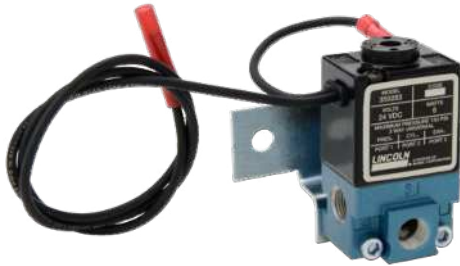

Description

Electric solenoid-operated air valves 350282 and 350283 operate as DC 3-way solenoid air valves. They are used to operate single-stroke, air-controlled pumps in single-line systems. Timer- and pressure-controlled air is supplied to the pumps, activating air-powered forward strokes and spring- (3-way) return strokes. In doing so, pumps discharge lubricant to the connected metering devices.

Features and benefits

- Timer- and pressure-controlled pump operation
- Use as 3-way solenoid valves
- For operation of single-stroke pumps
- Flexible usage selectable on electrical 12 or 24 VDC power requirements

Applications

- Mining and mineral processing
- Heavy machines

Technical data

Order number	350282 350283
Function principle	3-way solenoid air valve
Voltage supply:	
Model 350282	12 VDC, 6 VA
Model 350283	24 VDC, 6 VA
Operating temperature	-18 to +60 °C, 0 to +140 °F
Operating pressure .	max. 10 bar; 150 psi
Air inlet/outlet	1/8 NPT (F)
Cv factor	0.18
Mounting position	any



NOTE

Further technical information, technical drawings, accessories, spare parts or product function descriptions available on SKF.com/lubrication:

442832

Solenoid valve

253-14076-X



Description

Pumps in single-line systems can be supplied and actuated with compressed air via servo-controlled, 3/2-way piston valves (magnetic valve). For function and operation of the valve, a minimum differential pressure of 0,5 bar is requested. The valve is equipped with a control for initiation and check of function. Currentless, the valve is open to outlet A. It has a smooth-running servo piston. A 3/2-way pilot valve (tilting armature valve) provides safe and reliable operation.

Features and benefits

- Simple to install; no extra parts required
- Service friendly manual control of function
- Medium, separated pilot valve for higher operational safety
- Ground-optimized piston design for low switching pressure
- Power-saving pulse inductor

Applications

- Conveyors, transportation systems
- Chain lubrication
- Spray systems

Technical data

Function principle	3/2-way solenoid air valve with servo piston
Initial state	outlet A open
Operating temperature	-10 to +55 °C +14 to +131 °F
Operating pressure	0,5–16 bar; 7,3–232 psi
Supply voltage	110 VAC, 50 Hz
Model 253-14076-6	230 VAC, 50–60 Hz
Model 253-14076-7	
Power consumption	8 W
Protection class	IP 65
Air inlet	G 1/2
Air return connection	G 3/4
Nominal width	12 mm; 8.35 in, socket
Materials	brass, NBR
Output connection	socket for cable Ø 7 mm Ø 0.28 in
Dimensions	179,5 × 76 × 33 mm 7.06 × 3 × 1.3 in
Mounting position	any, especially impulse upward

Order information

Order number	Type	Operating voltage	Connection thread BSPP (F)
253-14076-6	3/2-way valve	110–120 VAC	G 1/2
253-14076-7	3/2-way valve	230 VAC	G 1/2



NOTE

Further technical information, technical drawings, accessories, spare parts or product function descriptions available on SKF.com/lubrication:

W-115-EN-1212

Solenoid valve

525-320 ...-1



Description

3/2-way solenoid valves are suitable to supply lubricant in different lubrication circuits and also are used as release valves. Each lubrication circuit can be connected to one pump outlet by switching off or switching on separately. Thereby, the pressure inlet is connected either to one or to the other circuit. Solenoid valves are equipped with a dry magnetic rotor and a conical seat valve. In their initial state, the valves always are open to the return line and are activated by a return spring. The current switching positions remain as long as current is switched on. Solenoid valves are switchable and resistant to compression in both flow directions.

Features and benefits

- Suitable to divide lubricant in different lubrication circuits on different time sequences
- Equipped with a dry magnetic rotor and a conical seat valve
- Switchable and resistant to compression in both flow directions

Applications

- Construction machinery
- Wind turbines
- Mining

Technical data

Function principle	3/2-way solenoid valve
Initial state	outlet B to R is open
Lubricant	oil, fluid grease and grease NLGI 0, 1, 2
Operating temperature	-20 to +60 °C -4 to +140 °F
Operating pressure	0-400 bar; 0-5 800 psi
Flow rate	max. 2 400 cm ³ /min max. 146.5 in ³ /min
Supply voltage	24 VDC, 110 VAC, 50 Hz 230 VAC, 50-60 Hz
Current draw	0,83 A; 0,2 A; 0,1 A
Rated power	20 W
Pressure connection	G 3/8
Protection class	IP 54
Isolation class	F
Materials	steel, aluminum
Dimensions	147 × 50 × 45 mm 5.78 × 1.96 × 1.77 in
Mounting position	any

Order information

Order number	Type	Operating voltage	Connection thread BSPP (F)
525-32085-1	3/2-way valve	24 VDC	G 3/8
525-32086-1	3/2-way valve	110 VAC	G 3/8
525-32087-1	3/2-way valve	230 VAC	G 3/8



NOTE

Further technical information, technical drawings, accessories, spare parts or product function descriptions available on SKF.com/lubrication:
W-115-EN-1212

Solenoid valve

161-110-031



Description

The directional valves are used to control the flow of lubricants, e.g. to divide up a central lubrication system into a number of lubrication circuits (zoned actuation) or to switch between circulating and intermittently operated lubrication circuits. Valves for a maximum pressure of up to 45 bar can be used for single-line lubrication systems with metering devices. Valves for a pressure range of up to 300 or 500 bar also are suitable for progressive systems.

Features and benefits

- Directional valves for oil with a low or high effective viscosity and greases up to NLGI Grade 2
- 2-, 4- or 5-way valve switching functions selectable for zoned actuations
- For single-line systems with sectional supplying of lubricants dependent upon different times and quantities
- Manual action possible

Applications

- Paper industry
- Steel industry
- Heavy industry

Technical data

Order number	161-110-031
Function principle	2/2-way solenoid valve
Lubricant	oil and grease up to NLGI 2
Operating temperatures:	
Oil, 4–1 500 mm/s ²	–40 to +80 °C; –40 to +176 °F
Grease, 700 mbar	–25 to +80 °C; –13 to +176 °F
Operating pressure	max. 500 bar, max. 7 250 psi
Hydraulic connector	G1/4
Materials	aluminum
Supply voltage	24 VDC
Rated current	0,67 A
Rated power	16 W, 5 W
Electrical connection	DIN EN175301-803
Protection class	IP 65 with plug
Dimensions	146,5 × 55 × 45 mm 5,77 × 2,17 × 1,77 in
Mounting position	any
Dimensions	179,5 × 76 × 33 mm 7,06 × 3 × 1,3 in



NOTE

Further technical information, technical drawings, accessories, spare parts or product function descriptions available on SKF.com/lubrication: |

1-1703-EN

Solenoid valve

161-140-050



Description

These directional valves are used to control the flow of lubricants, e.g. to divide up a central lubrication system into a number of lubrication circuits (zoned actuation) or to switch between circulating and intermittently operated lubrication circuits. Valves for a maximum pressure of up to 45 bar can be used for single-line lubrication systems with metering devices. Valves for a pressure range of up to 300 or 500 bar also are suitable for progressive systems.

Features and benefits

- Directional valves for oil with a low or high effective viscosity and greases up to NLGI Grade 2
- 2-, 4- or 5-way valve switching functions selectable for zoned actuations
- For single-line systems with sectional supplying of lubricants dependent upon different times and quantities
- Manual action possible

Applications

- Paper industry
- Steel industry
- Heavy industry

Technical data

Order number	161-140-050
Function principle	4/2-way valve
Lubricant	oil and grease up to NLGI 2
Valve, basic position	sliding, open P to A
Operating temperatures:	
oil, 4-1 500 mm/s ²	-40 to +80 °C; -40 to +176 °F
grease, 700 mbar	-25 to +80 °C; -13 to +176 °F
Operating pressure	max. 320 bar; max. 4 350 psi
Hydraulic connector	base plate G 1/4
Materials	aluminum
Supply voltage	DC and AC
Rated current	1,33 A at 24 VDC; 0,17 A at 220 VAC, 50 Hz
Rated power	16 W, 5 W
Electrical connection	DIN EN175301-803
Protection class	IP 65 with plug
Dimensions	148 × 58 × 45 mm 5.83 × 2.28 × 1.77 in
Mounting position	any



NOTE

Further technical information, technical drawings, accessories, spare parts or product function descriptions available on SKF.com/lubrication:

1-1703-EN

Index

24-1074-2210.....	155	321-403W1.....	115	321-606W1.....	115	352-040-K.....	107
24-1074-2240.....	155	321-403W2.....	115	321-606W2.....	115	352-040-K-S8.....	107
24-1074-2270.....	155	321-403W3.....	115	321-606W3.....	115	352-040-S8-VS.....	107
161-110-031.....	196	321-406G1.....	115	321-610G1.....	115	352-040-VS.....	107
161-120-067+910.....	25	321-406G2.....	115	321-610G2.....	115	352-060-K.....	107
161-120-067+924.....	25	321-406G3.....	115	321-610G3.....	115	352-060-K-S8.....	107
161-140-050.....	197	321-406G4.....	115	321-610G7.....	115	352-060-S8-VS.....	107
169-400-405.....	25	321-406G7.....	115	321-610T1.....	115	352-060-VS.....	107
179-990-033 / -147.....	33	321-406G7-S8.....	115	321-610T2.....	115	391-010-K-S1.....	113
179-990-371 / -381.....	33	321-406T1.....	115	321-610T3.....	115	391-020-K.....	113
179-990-372 / -382.....	33	321-406T2.....	115	321-610W1.....	115	391-020-K-S1.....	113
179-990-486.....	167	321-406T3.....	115	321-610W2.....	115	391-020-K-S8.....	113
223-12289-7.....	141	321-406W1.....	115	321-610W3.....	115	391-030-K-S1.....	113
234-10330-4.....	182	321-406W2.....	115	321-616G7.....	115	391-040-K.....	113
234-11272-4.....	183	321-406W3.....	115	321-620G7.....	115	391-040-K-S8.....	113
234-13161-5.....	184	321-410G1.....	115	321-630G7.....	115	391-060-K.....	113
234-13161-9.....	180	321-410G2.....	115	341-453-K-S8.....	97	391-060-K-S8.....	113
236-10153-3.....	189	321-410G3.....	115	341-453-S8-VS.....	97	391-100-K.....	113
236-10567-5.....	165	321-410G4.....	115	341-456-K-S8.....	97	391-100-K-S8.....	113
236-10567-6.....	165	321-410G7.....	115	341-456-S8-VS.....	97	391-150-K.....	113
236-10850-7.....	167	321-410G7-S8.....	115	341-460-K-S8.....	97	391-150-K-S8.....	113
236-10850-8.....	167	321-410T1.....	115	341-460-S8-VS.....	97	406-004-VS.....	25
236-10850-9.....	167	321-410T2.....	115	341-466-K-S8.....	97	406-004-VS.....	33
236-10980-6.....	167	321-410T3.....	115	341-466-S8-VS.....	97	408-004-VS.....	25
236-10986-1.....	189	321-410W1.....	115	341-853-K.....	97	408-0074-VS.....	33
236-11066-1.....	167	321-410W2.....	115	341-853-VS.....	97	447-71899-1.....	121
237-11204-8.....	69	321-410W3.....	115	341-856-K.....	97	447-71901-1.....	121
237-11204-8.....	75	321-601G1.....	115	341-856-VS.....	97	447-71902-1.....	121
253-14076-6.....	194	321-601G2.....	115	341-860-K.....	97	447-71903-1.....	121
253-14076-7.....	194	321-601T2.....	115	341-860-VS.....	97	447-71904-1.....	121
321-101.....	115	321-601T3.....	115	352-005-K.....	107	447-71905-1.....	121
321-103.....	115	321-601W1.....	115	352-005-K-S8.....	107	447-71906-1.....	121
321-106.....	115	321-601W2.....	115	352-005-S8-VS.....	107	451-006-060.....	33
321-401G1.....	115	321-601W3.....	115	352-005-VS.....	107	451-008-060.....	33
321-401G2.....	115	321-603G1.....	115	352-010-K.....	107	454-71505-1.....	141
321-401G3.....	115	321-603G2.....	115	352-010-K-S8.....	107	454-71506-1.....	141
321-401G7.....	115	321-603G3.....	115	352-010-K-S82.....	107	454-71507-1.....	141
321-401T2.....	115	321-603T1.....	115	352-010-S8-VS.....	107	454-71508-1.....	141
321-401W2.....	115	321-603T2.....	115	352-010-S82-VS.....	107	454-71509-1.....	141
321-403G1.....	115	321-603T3.....	115	352-010-VS.....	107	466-421-001.....	25
321-403G2.....	115	321-603W1.....	115	352-020-K.....	107	466-431-001.....	33
321-403G3.....	115	321-603W2.....	115	352-020-K-S8.....	107	506-140-VS.....	25
321-403G4.....	115	321-603W3.....	115	352-020-K-S82.....	107	506-140-VS.....	33
321-403G7.....	115	321-606G1.....	115	352-020-S8-VS.....	107	525-32083-1.....	91
321-403G7-S8.....	115	321-606G2.....	115	352-020-S82-VS.....	107	525-32085-1.....	195
321-403T1.....	115	321-606G3.....	115	352-020-VS.....	107	525-32086-1.....	195
321-403T2.....	115	321-606T2.....	115	352-030-K-S82.....	107	525-32087-1.....	195
321-403T3.....	115	321-606T3.....	115	352-030-S82-VS.....	107	532-34839-2.....	189

Index

532-34839-3	189	995-901-065	33	80072	85	83167	61
532-34839-5	189	995-993-610	107	80073	85	83309-1	133
532-34839-6	189	995-993-610-VS	107	80074	85	83309-2	133
532-37731-1	189	995-993-620	107	80075	85	83309-3	133
541-34901-4	33	995-993-620-VS	107	80076	85	83309-4	133
541-34901-5	33	995-993-630	107	80077	85	83309-5	133
547-33924-1	121	995-993-630-VS	107	80078	85	83309-6	133
547-33925-1	121	995-993-660	107	80079	85	83313	123
547-33926-1	121	995-994-003	97	80080	85	83314	133
554-32810-1	141	995-994-006	97	80081	85	83314-9	133
554-32811-1	141	995-994-010	97	80083	85	83336HV-1	138
554-32812-1	141	995-994-016	97	80084	85	83336HV-2	138
554-32813-1	141	995-994-103	97	80085	85	83336HV-3	138
554-32814-1	141	995-994-103-VS	97	80086	85	83336HV-4	138
554-34387-1	141	995-994-106	97	80087	85	83336HV-5	138
645-41062-3	77	995-994-106-VS	97	80088	85	83336HV-6	138
645-41062-4	77	995-994-110	97	80089	85	83336HV-7	138
645-41062-7	77	995-994-110-VS	97	80090	85	83336HV-8	138
645-41062-8	77	995-994-116	97	80091	85	83336HV-9	138
645-41062-9	77	995-994-116-VS	97	80105	85	83336HV-10	138
645-41064-2	77	997-000-185	154	80106	85	83337HV	138
645-41064-3	77	1810	53	80107	85	83338HV	138
645-41064-4	77	1812	16	80108	85	83535	123
645-41064-6	77	1826	31	80109	85	83599	62
645-41064-7	77	2340-00000108	185	80110	85	83660	125
645-41064-8	77	2340-00000118	181	80111	85	83662	125
645-41073-5	77	3515-07-2022	167	80112	85	83667	19
645-41110-2	77	3515-07-6120	167	80120	85	83668	56
645-41110-3	77	3515-10-2021	167	80121	85	83715-1	133
645-41119-1	77	3515-10-6020	167	80122	85	83715-2	133
645-41119-2	77	3515-10-6120	167	80127	35	83715-3	133
645-41175-5	77	3515-10-6320	167	80128	35	83715-4	133
647-41151-2	121	3515-10-6620	167	80134	85	83715-6	133
647-41152-2	121	3515-10-7620	167	80135	85	83715-7	133
647-41152-4	121	11962	127	81770-1	139	83748	129
647-41153-2	121	11962	129	81770-2	139	83800	60
647-41154-4	121	11963	127	81770-3	139	83817	52
647-41154-5	121	11963	129	81770-4	139	83834	60
647-41154-6	121	11964	127	81770-5	139	83900	133
647-41154-7	121	11964	129	81770-6	139	83900-9	133
647-41155-2	121	11965	127	82292	127	84048	123
647-41156-2	121	11965	129	82295	127	84050	72
664-34135-6	163	12658	127	82570	28	84050	75
664-34135-7	163	12658	129	82653	60	84050MSO	75
898-110-120	33	14253	123	82655	60	84060	75
898-210-001	103	14312	123	82676	27	84060MSO	75
995-901-061	25	14361	123	82885	19	84110	125
995-901-063	25	69630	176	82886	56	84501	161

Index

84616.....	69	85730.....	91	91884-1.....	125	12375080.....	87
84616.....	75	85730MSO.....	91	91885-1.....	125	12375120.....	87
84944.....	66	85731.....	69	91886-1.....	125	12375160.....	87
84960.....	67	85732.....	69	91976-1.....	123	12375200.....	87
84961.....	66	85733.....	69	249279.....	123	12380210.....	157
84962.....	67	85734.....	69	249279.....	125	12380220.....	157
84980.....	69	85735.....	69	249280.....	123	12380600.....	158
84980.....	75	85736.....	91	249280.....	125	12380692.....	158
84990.....	69	85737.....	91	249281.....	123	12380747.....	83
84990.....	75	85738.....	91	249281.....	125	12380747.....	157
85307.....	164	85739.....	91	249282.....	123	12380760.....	156
85307-DS.....	164	85740.....	91	249282.....	125	12380765.....	156
85430.....	29	85741.....	69	249649.....	123	12381280.....	87
85431.....	29	85742.....	69	270982.....	69	12381285.....	87
85432.....	29	85743.....	91	270982.....	75	12381290.....	87
85433.....	29	85744.....	91	270982.....	91	12381292.....	87
85434.....	59	85745.....	91	271605.....	69	12381294.....	87
85435.....	59	85746.....	91	271605.....	75	12381296.....	87
85436.....	59	85747.....	91	271606.....	69	12381381.....	71
85438.....	20	85748.....	91	271606.....	75	12381382.....	71
85440.....	20	85749.....	91	272180.....	91	12381383.....	71
85441.....	20	85750.....	91	274899.....	91	12381384.....	71
85442.....	57	85751.....	91	276325.....	91	12381385.....	71
85444.....	58	85752.....	91	276764.....	77	12381386.....	71
85445.....	58	85753.....	91	276765.....	77	12381700.....	71
85460.....	72	85754.....	91	276903.....	91	12381701.....	71
85474.....	91	85770-1.....	147	276919.....	91	12381702.....	71
85475.....	91	85770-2.....	147	279630.....	164	12382666.....	71
85479.....	91	85770-3.....	147	282288.....	73	12389912.....	83
85492.....	69	85770-4.....	147	283167.....	18	12389916.....	83
85492.....	75	85770-5.....	147	350241.....	192	12389919.....	83
85492.....	91	85770-6.....	147	350242.....	192	12389924.....	83
85497.....	146	85771.....	147	350244.....	192	12389925.....	83
85664.....	91	85772.....	147	350245.....	192	12389936.....	83
85665.....	91	086500.....	166	350282.....	193	12389937.....	83
85722.....	69	086501.....	166	350283.....	193	12389942.....	83
85722MSO.....	69	086502.....	166	11390060.....	63	12389943.....	83
85723.....	69	086503.....	166	11390070.....	63	12389944.....	83
85724.....	69	086504.....	167	11395200.....	83	12389953.....	83
85725.....	69	086505.....	167	11395210.....	83	12389954.....	83
85725MSO.....	69	086506.....	167	11395211.....	83	12501270.....	156
85726.....	69	086507.....	167	11395227.....	83	ACP15-1WA11X2-F10.....	23
85727.....	69	86535.....	162	11395254.....	83	ACP15-1WA11X2-F17.....	23
85727MSO.....	69	91863-1.....	123	11500608.....	160	ACP15-1WA11XX-U10.....	23
85728.....	91	91864-1.....	123	11500610.....	83	ACP15-1WA11XX-U17.....	23
85728MSO.....	91	91865-1.....	123	11500610.....	159	ACP15-10A11X2-F05.....	23
85729.....	91	91866-1.....	123	12375000.....	87	ACP15-10A11X2-F10.....	23
85729MSO.....	91	91883-1.....	125	12375040.....	87	ACP15-10A11X2-F17.....	23

Index

ACP15-10A11XX-U05	23	KFBS1-M-W+924	39	MFE5-BW3-2-S34+1FV	47	VKU005-K	119
ACP15-10A11XX-U10	23	KFBS1-W+912	37	MFE5-BW3-S41+MPG	47	VKU010-K	119
ACP15-10A11XX-U17	23	KFBS1-W+924	37	MFE5-BW7+299	47	VKU020-K	119
BPH30-3001AB-VAOM	64	KFBS1-W-4-S1+912	37	MFE5-BW7-S22+1FV	47	VKU030-K	119
BPH30-3101AB-VAOM	64	KFBS1-W-4-S1+924	37	MFE5-BW7-S97+1FW	47	VKU040-K	119
DSC1-B040E-2A2B	177	KFBS1-W-6-S1+912	37	MFE5-BW7-S107+MPG	47	VKU060-K	119
DSC2-A100E-2A2B	178	KFBS1-W-6-S1+924	37	MFE5-BW7-S222+MPG	47	VKU100-K	119
DSC3-A100K-3A2B	179	KFU2-40+912	41	MFE5-BW16+299	47		
EXZT2A02+471	153	KFU2-40+924	41	MFE5-BW16-S96+MPG	47		
EXZT2A02+472	153	KFU6-20+912	41	MFE5-BW16-S145+1FV	47		
EXZT2A05+471	153	KFU6-20+924	41	MFE5-BW16-S222+MPG	47		
EXZT2A05+472	153	KFUS2-64+912	41	MFE5-BW30+299	47		
EXZT2A07+471	153	KFUS2-64+924	41	MFE5-BW30-S30+29E	47		
EXZT2A07+472	153	LF001/MR380	33	MFE5-BW30-S35+MPG	47		
GS304P	188	LS2110	99	MFE5-BW30-S222+MPG	47		
IG 502-2-E+912	154	LS2120	99	MFE5-K3-2+299	47		
IG 502-2-E+924	154	LS2130	99	MFE5-K6+299	47		
IGZ36-20+471	153	LS2140	99	MFE5-KW3-2+299	47		
IGZ36-20+472	153	LS2150	99	MFE5-KW3-2-S4+299	47		
IGZ36-20-S6+471	153	LS2210	98	MFE5-KW3-S24+MPG	47		
IGZ36-20-S6+472	153	LS2220	98	MFE5-KW3-S35+1FW	47		
IGZ38-30+471	153	LS2230	98	MFE5-KW3-S37+1FV	47		
IGZ38-30+472	153	LS2240	98	MFE5-KW6+299	47		
IGZ38-30-S1+471	153	LS2250	98	MFE5-KW6-S1+299	47		
IGZ38-30-S1+472	153	MCP15-1WA01X2-F10	15	MFE5-KW6-S33+MPG	47		
IGZ51-20-S3+471	153	MCP15-1WA01X2-F17	15	MFE5-KW6-S42+1FV	47		
IGZ51-20-S3+472	153	MCP15-1WA01XX-U10	15	MFE5-KW6-S102+1FW	47		
KFB1+912	37	MCP15-1WA01XX-U17	15	P-289	21		
KFB1+924	37	MCP15-10A01X2-F05	15	P-846-2	17		
KFB1-4-S1+912	37	MCP15-10A01X2-F10	15	P-886	26		
KFB1-4-S1+924	37	MCP15-10A01X2-F17	15	PEF-90	30		
KFB1-6-S1+912	37	MCP15-10A01XX-U05	15	PEF-99W	30		
KFB1-6-S1+924	37	MCP15-10A01XX-U10	15	PEF-99W-S1	30		
KFB1-M+924	39	MCP15-10A01XX-U17	15	PEF-99W-S2	30		
KFB1-M-W+924	39	MFE2-K3-2+299	47	PEF-99W-S3	30		
KFB1-W+912	37	MFE2-K3F-2+299	47	PEU-99	30		
KFB1-W+924	37	MFE2-K6F+299	47	PEU-99-S2	30		
KFB1-W-4-S1+912	37	MFE2-K6F-S2+299	47	PEU-99-S3	30		
KFB1-W-4-S1+924	37	MFE2-KW3F-S9+MPG	47	PF-289	21		
KFB1-W-6-S1+912	37	MFE2-KW3F-S13+1FV	47	PFW-289	21		
KFB1-W-6-S1+924	37	MFE2-KW6F-S1+299	47	PW-289	21		
KFBS1+912	37	MFE2-KW6F-S20+MPG	47	V71-010	109		
KFBS1+924	37	MFE2-KW6F-S37+1FV	47	V71-020	109		
KFBS1-4-S1+912	37	MFE2-KW6F-S41+1FW	47	V71-040	109		
KFBS1-4-S1+924	37	MFE5-B3-2+299	47	V71-060	109		
KFBS1-6-S1+912	37	MFE5-B7+299	47	V71-100	109		
KFBS1-6-S1+924	37	MFE5-BW3-2+299	47	V71-150	109		
KFBS1-M+924	39	MFE5-BW3-2-S28+299	47	V72-005	109		



Important information on product usage

SKF and Lincoln lubrication systems or their components are not approved for use with gases, liquefied gases, pressurized gases in solution and fluids with a vapor pressure exceeding normal atmospheric pressure (1 013 mbar) by more than 0,5 bar at their maximum permissible temperature.

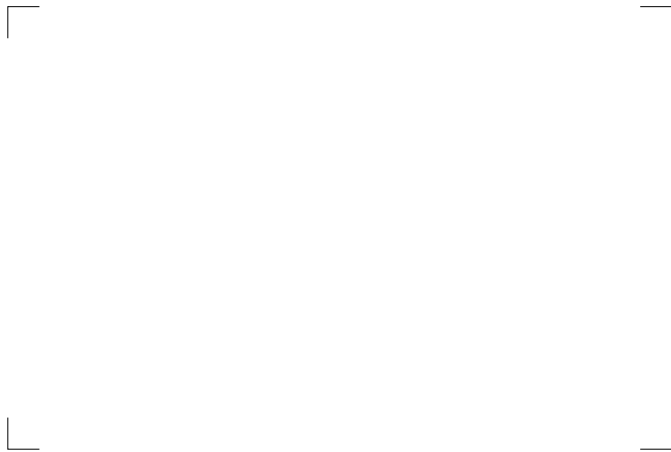

skf.com | skf.com/lubrication | lincolnindustrial.com

© SKF and LINCOLN are registered trademarks of the SKF Group.
APPLE APP STORE is a service mark of Apple Inc.
GOOGLE PLAY is a trademark of Google LLC.

© SKF Group 2021

The contents of this publication are the copyright of the publisher and may not be reproduced (even extracts) unless prior written permission is granted. Every care has been taken to ensure the accuracy of the information contained in this publication but no liability can be accepted for any loss or damage whether direct, indirect or consequential arising out of the use of the information contained herein.

PUB LS/P1 17046 EN · Juni 2021

Certain image(s) used under license from Shutterstock.com